



**KTH Architecture and
the Built Environment**

Industrial Fibre Concrete Floors

Experiences and Tests on Pile-Supported Slab

Jerry Hedebratt

August 2012

TRITA-BKN. Bulletin 113, 2012

ISSN 1103-4270

ISRN KTH/BKN/B—113--SE

Copyrights: Jerry Hedebratt

Copyrights for photos according to figure texts. Right to reproduce the photo of World heritage Shibam is acquired from UNESCO.

Printed by US-AB, Stockholm, September 2012.

Preface

The research work presented in this thesis was partly carried out at the Department of Civil and Architectural Engineering, Royal Institute of Technology (KTH) and partly at Tyréns AB between January 2001 and August 2012. The study have partly been carried out on a half-time occupation and due to the nature of the project with long term studies on the behaviour and performance of industrial pile supported floors this fairly long time was needed. Consequently many actors have been involved and a number of fruitful case studies have been performed during the work. The case studies have been financed by several individual partners; that I have involved in this research project. The main finance is from the Sven Tyréns Foundation, Stockholm, The Development Fund of the Swedish Construction Industry (SBUF), and the Division of Structural Design and Bridges at KTH. Other financial and material contributors are Tyréns AB, Stockholm, Bekaert Building Products, Belgium, Bekaert Svenska AB, Göteborg, Swedish Cement and Concrete Research Institute, CBI, Stockholm, AB Linotolgov, Kungsör, Kilenkryset AB, Strängnäs and Modern Betong AB, Täby.

The research work was initiated by Professor Johan Silfwerbrand as part of a joint Research and Development project (R&D) between the industry (represented by SBUF) and the University (KTH). The academic supervisors have been Professor Johan Silfwerbrand, Professor Håkan Sundquist and associated Professor Bo Westerberg.

The reference group consisted of representatives from the construction industry and consultant engineers, Ali Farhang, Ramböll, Peter Mjörnell, Bekaert Svenska, and Bo Westerberg, (earlier Tyréns), Bengt Ström, NCC Teknik, Bo Malmberg, WSP-Group, Jonatan Paulson-Tralla, Projektengagemang, Per Murén, NCC Ballast and Margareta Slade, Abetong (earlier Kilenkryset) and has taking part at reference group meetings. Thank you for listen and sharing views of the matter, valuable trends to follow up and support.

Especially I would thank Peter Mjörnell, Bekaert Svenska AB, and Anne Hooekstra, Bekaert, Belgium, for their endurance and long term qualities helping me with fibre material, testing, guidance and finance. Also Magnus Hanson, Bekaert Svenska AB has been a contributing listener over the years past. Also the test personal led by Tomas Bonamie, at Beakert

Laboratory in Kortrijk, Belgium, has been very helpful as well as and all other people at Bekaert, not to forget Gerhard Vitt, Bekaert Germany.

I would also like to express my deepest gratitude to Conny Gustafsson, AB Linotolgov, who has financed part of the full-scale testing site and has contributed with concrete working crew at the test site and also been an inexhaustible source of experience and knowledge in the matter of industrial floors.

I would like to express my deepest gratitude to my supervisor Professor Johan Silfwerbrand and assistant supervisor Professor Bo Westerberg for encouragement, support and experienced guidance. Professor Johan Silfwerbrand especially has with assiduous endurance guided me in times where the direction has been poorly staked and when the thresholds have seemed to be enormous and when the energy to go even further was empty – thank you for always pushing forward, enlighten me and listen on my sometimes complicated ideas. Bo Westerberg, thank you for guidance in technical calculations.

Thank you also to the laboratory technicians at KTH Stefan Trillkott and Claes Kullberg for professional help with designing test equipment and instrumentation and assistance in load testing – also for joy and interested questions when performing their qualified test routines.

I also would thank the working group members of the Swedish Concrete Association's, (SCA) committee on Industrial Concrete Floors involving Bengt Ström (retired from NCC Roads), Ph.D. Jonas Carlsvärd (Betongindustri), Professor Johan Silfwerbrand (CBI), and Göran Hällerstål, Färdig Betong (numera Anjobygg) and Bo Malmberg (WSP Group) and Ph.D. Ingemar Löfgren (TCG) that provided with an appendix, for interesting discussions and valuable comments on my work and concrete floors in general, in many occasions and fruitful meetings.

The interested personnel at CBI for listening and fruitful discussions, the laboratory technicians Göran Olsson and Lars Mellin for exclusive testing, Tuula Ojala, librarian at CBI, for finding literature that you could not imagine existed.

The PhD students, colleagues and friends at the Division of Structural Design and Bridges and the Division of Concrete Structures – nobody mentioned, nobody forgotten – for joy and interested questions.

Of greatest help and with largest possible sacrifices my family has with perseverance stood by my side. My wife Marika, my sons Mats and Filip and Felicia, my beautiful daughter, thank you for patience, understanding and for always being there.

Stockholm, August 2012

Jerry Hedebratt

Abstract

Pile supported floor slabs have often been designed solely in ultimate limit state ULS and then foremost with uniformly distributed loadings UDL. The investigation of serviceability limit state SLS has been of simpler nature, even according to the governing codes of practice.

Often it has been minimum-reinforced with the presumption that full friction to the supporting ground is present, without any inspection, which by the Swedish code of practice even more reduced the addition of crack reinforcement. The cracks have not been controlled, before they in fact have occurred. For pile supported floor slabs the ground support will be there still, at least for a time, after the casting. As the ground settles, as dehydration always will occur, and drainage and the covering roof the precipitation to reach the ground, the slab will often be completely free bearing between the piles. The minimum reinforcement is based on the assumption that only the upper layer is needed to reinforce due to dehydration shrinkage – despite that the whole floor section in time will obtain the same moisture profile and also shrinkage magnitude. One often excludes the influence of creep and temperature and the affect from external loading and local variance of restraints in calculations in the SLS. Research on behaviour in SLS has been modest; in spite of that the contractors and the client and finally the end-user of the floors often suffer from these problems.

It has by this thesis been established that the shrinkage of the concrete used for industrial floors is large 0.9-1.1 ‰, and that the problem foremost arise from cracking and problems with joints and unevenness in the floor. The integrated method for design and production of industrial floors is a way to the solution, but requires that all involved assign to co-operate to 100 %. Furthermore it is required that one selects the proper materials to the proper design and the proper production method. If one will save cost this will often be on materials; which will lead to reduced reinforcement content and reduced concrete thickness. This way is wrong and will in end make the client suffer economically. A way to solve this has been to cast the floors with steel fibre concrete SFC; from the beginning often a little bit thicker and with moderate steel fibre content and complementary reinforcement, compared to present execution. The competition from abroad has nevertheless shaped solutions that with thinner slabs and less traditional reinforcement and invalid design calculations compete on faulty grounds. This work demonstrates how this make the floor suffer in ULS and SLS.

Trough full-scale testing (half of a normally loaded industrial floor in matter of geometry) where a pile supported floor slab has been simulated by a flat-slab floor cast in steel fibre concrete, it has been shown that the solution with steel fibre concrete performs well in slabs for industrial floors. On one hand it gives the opportunity to production wise superior methods for placing concrete which potentially could gain the environment with reduced reinforcement content, and on the other hand SFC brings a ductile failure behaviour for loadings with much larger magnitudes than in normal ULS design, and further SFC provides with a stiffer response and with possibility to construct slabs with small creep deformation.

Finally it has been established that, when it comes to short-term point loadings (ULS) and with long-term point loadings (SLS) one can rely on the bearing capacity and the tough behaviour of SFC. And that one may exert an influence on both limit states, through variation of the SFC and the reinforcement content. This is shown for a real bearing structure, the pile supported industrial floor, and that in a safe way.

Sammanfattning

Pålunderstödda golv har ofta dimensionerats enbart i brottgränstillståndet och då främst för utbredd belastning. Utredningen av bruksgränstillståndet har varit av enklare karaktär, även enligt gällande normer. Oftast har man använt minimiarmering med antagandet att full friktion råder till underlaget, utan undersökning; vilket genom den svenska normen har än mer reducerat inläggning av sprickarmeringen. Sprickvidderna har man inte kontrollerat, förrän sprickorna de facto har uppstått. För pålunderstödda golv finns markstödet kvar, åtminstone för en tid, efter gjutningen. Allteftersom marken sätter sig, då avvattningsalltid sker, via dränering och taktäckning som utestänger nederbörden att nå marken, blir plattan ofta helt fribärande mellan pålarna. Minimiarmeringen baseras på antagandet att enbart det övre skiktet behöver armeras på grund av uttorkningskrympning – trots att hela golvets sektion på sikt erhåller samma fuktprofil och lika stor slutkrympning. Man utesluter ofta inverkan av krypning, temperatur, påverkan av yttre last och lokalt varierande tvång i beräkningar i bruksstadiet. Forskningen inom verkningssätt i bruksstadiet har varit blygsam, trots att det är de problemen som ofta drabbar entreprenör, kunden och slutligen användaren av golvet.

Det har i avhandlingen konstaterats att krympningen för den betong som används i industrigolv är stor, 0,9-1,1 %, och att problemen främst härrör till sprickor och problem med fogar och ojämnheter i golvet. Den integrerade metoden för projektering och produktion av industrigolv är en väg till lösningen, men kräver att alla ställer upp på att samarbeta till 100 %. Dessutom krävs att man väljer rätt material till rätt konstruktion och till rätt utförandemetod. Vill man spara så blir det ofta på material som medför minskat armeringsinnehåll och minskad betongtjocklek. Detta är en felaktig väg som till sist drabbar kunden ekonomiskt. Ett sätt att lösa detta har varit att gjuta golven av stålfiberbetong SFC; från början ofta lite tjockare och med moderat stålfiberinnehåll och kompletterande armering, jämfört med dagens utförande. Konkurrensen från utlandet har dock skapat lösningar med tunnare plattor, minskad mängd fibrer och mindre eller utesluten traditionell armering och ogiltiga dimensioneringsberäkningar, dvs. lösningar som konkurrerar på felaktiga grunder. Detta arbete påvisar hur detta går ut över golvets beteende i brottstadiet och i bruksstadiet.

Genom försök i fullskala (hälften av ett normalbelastat industrigolv i avseende på geometrin) där ett pålunderstött golv har simulerats av ett pelardäck gjutet av stålfiberbetong, har det visat sig att lösningen med stålfiberbetong fungerar väl i plattor för industrigolv. Dels ger det möjlighet till produktionsmässigt överlägsna utläggningsmetoder som potentiellt kan gynna miljön med minskad armeringsmängd, dels medför SFC ett segt brottbeteende för laster långt större än det normala i brottstadiet, och vidare så medför stålfiberbetongen ett styvare beteende med möjlighet att utföra plattor med liten krypdeformation.

Slutligen har visats, både när det gäller för korttidslast (brottstadiet) och långtidslast (bruksstadiet) att man kan lita på bärförmågan och det sega brottbeteendet hos SFC. Dessutom visas att man kan påverka båda stadier genom att variera stålfiberbetongen och armeringsinnehållet. Detta gäller för en verkligt bärande konstruktion, det pålunderstödda industrigolvet, och det på ett tryggt sätt.

List of publications

This thesis consists of an extensive summary and four appended papers.

- Paper A** Hedebratt, J. & Silfwerbrand J. (2008). *Damages in Industrial Concrete Floors, published in Swedish Concrete Society, Concrete reports no 13: Industrial floors – recommendations for design, material selection, execution, operation and maintenance.* Swedish Concrete Society, Stockholm. Chapter 2 (Skador): pp. 63-85, Translated from Swedish by Jon Van Leuven.
- Paper B** Hedebratt, J. & Silfwerbrand J. (2012a). *Lessons Learned – Swedish Design and Construction of Industrial Concrete Floors,* published in Nordic Concrete Research, vol. 45, June 2012, pp. 75-91.
- Paper C** Hedebratt, J. & Silfwerbrand J. (2012b). *Full Scale Test of a Pile Supported Steel Fibre Concrete Slab.* Submitted to Rilem: Materials & Structures, 6th Mars 2012, 29 pp.
- Paper D** Hedebratt, J. & Silfwerbrand J. (2012c). *Long Term Full Scale Test of a Pile Supported Steel Fibre Concrete Slab.* Submitted to American Concrete Institute ACI, Concrete International, 5th May 2012, 20 pp.

The papers were prepared in collaboration with co-author. The author of this thesis took the following responsibility for the work in those papers:

- Paper A** The author performed the theoretical study and made interviews with contractors and consultants and all writing (in Swedish) and illustrations. The author has visited for inspection numerous of damaged floors. The author also took part on committee meetings as secretary. Prepared material for floor course and held lessons at the Swedish Cement and Concrete Research Institute.
- Paper B** The author has in commission designed and often been involved in the quality assurance in the building of the floors, the planning and discussion of different solutions on behalf of the contractor but also in helping the client with the necessary demands. The paper is a product of many years of work with frequent visits of many of the floors and also contacts with clients, material suppliers and contractors. Wrote the paper and also presented the first part of the study at the 6th Colloquium Industrial Floors 2007 in Esslingen, Germany.

Paper C The author has planned, designed and project managed and taken part of the construction of the full-scale experiment and the material testing. The planning of the project included design calculations, preliminary drawings, building permit drawings and construction drawings. And also time schedule and economic planning of budget and financing of the project. In the construction phase the author excavated the ground and took part in placing the bottom slab reinforcement and project managed the casting of steel fibre concrete. The walls and columns were designed by the author who also project managed the prefabrication. The invention of the design and installations of formwork, and welding of wall connections, and supervision of casting of the flat slab were by the author. The test-setup was planned with help of KTH laboratory personal but the loading equipment including the welding and other production of load alternator and installation of the equipment was performed by the author. Also supervision of the material testing in Bekaert laboratory in Belgium and the analysis and writing of the paper is also by the author. The initial stages of planning and the intensions of the full-scale test have been presented at International Symposium on *Innovation & Sustainability of Structures in Civil Engineering - Including Seismic Engineering*, November 20-22, 2005, Nanjing, China and at the Nordic Mini-Seminar 2007: *Fibre reinforced concrete structures* hosted by NTNU Department of structural engineering and SINTEF Building and Infrastructure. Part of the results was later presented in a short paper and in a poster at the International fib Symposium 2008: *Tailor Made Concrete Structures - New Solutions For Our Society* hosted by Joost Walraven and Dick Stoelhorst in Amsterdam, The Netherlands, and at the XXth Symposium on Nordic Concrete Research & Development in Bålsta, Sweden. 2008.

Paper D Following the preparation and work with the testing in **Paper C** the author has planned, designed and project managed the construction of the full-scale experiment and the material testing that are described in the **Paper D**. The test setup was planned with help of the co-author but the design and construction of the test equipment was by the author, including welding and assembling of equipment (lever mechanism) and casting of weights. The manual sampling of read-outs and analysis and writing of the skeleton (body) of the paper is also by the author. The editor (Rex C. Donahey, Concrete International) has made substantial editorial changes to the original manuscript and helped with proofreading.

The second author has regarding the four papers been helpful in proofreading and assisted with wise comments on the text and analysis, and been a valuable listener and partner in discussion. He has also at several occasions visited the test sites, in Eskilstuna, Södertälje, Tumba and Västerås. He has also taken part of the education of manpower for the worksite in the third pilot study, a part of the integrated method.

Other publications by the author

Licentiate thesis

Hedebratt, J. (2004). *Integrated Design and Construction of Industrial Floors – Methods to Increase the Quality*, Licentiate thesis, Report no 78, Department of Structural Design and Bridges, Royal Institute of Technology, KTH, Stockholm, Sweden, 232 pp. (In Swedish)

Conference papers

Silfwerbrand, J. & Hedebratt, J. (2008). *Full-Scale Test on a Pile Supported Floor Slab – Steel Fibre Concrete Only or in a Combination with Steel*. Proceedings of the XXth Symposium on Nordic Concrete Research & Development, Bålsta, Sweden, June 8-11, 2008, 2 pp.

Silfwerbrand, J. & Hedebratt, J. (2007). *Full-Scale Test on a Pile Supported Floor Slab – Steel Fibre Concrete Only or in a Combination with Steel*. Proceedings of the Nordic Miniseminar: Fibre Reinforced Concrete, Department of Structural Engineering, Norwegian University of Science and Technology, NTNU, Trondheim, Norway, November 15th, 2007, 4 pp.

Silfwerbrand, J. & Hedebratt, J. (2006a). *Swedish Guidelines for Industrial Concrete Floors*. Proceedings of the 6th International Colloquium on Industrial Floors, Ostfildern, Germany, January 16-18, 2007, 11 pp.

Hedebratt, J. & Silfwerbrand, J. (2006b). *Lessons Learned – Swedish Design of Industrial Concrete Floors*. Proceedings of the 6th International Colloquium on Industrial Floors, Ostfildern, Germany, January 16-18, 2007, 8 pp.

Hedebratt, J. & Silfwerbrand, J. (2005) *Full-Scale Tests on Pile Supported Floor Slabs – Steel Fibre Reinforced Concrete Only or in a Combination with Steel*. Proceedings of the International Symposium on Innovation & Sustainability of Structures in Civil Engineering-Including Seismic Engineering (Volume 1), November 20-22, 2005, Nanjing, China, 2005, pp. 437-448.

Hedebratt, J. & Silfwerbrand, J. (2005). *Design of Suspended Pile Supported SFRC Slabs – Combined Reinforcement in Industrial Floors*. Proceedings of the

XIX Symposium on Nordic Concrete Research. Sandefjord, Norway. 13th-15th June, 4 pp.

Hedebratt, J. & Silfwerbrand, J. (2004). *Integrated Design and Construction of Industrial Floors - An Innovative Approach to the Design of Pile Supported SFRC Slabs*. Proceedings of the 6th Rilem Symposium on Fibre-Reinforced Concretes, BEFIB 2004 edited by M. di Prisco, R. Felicetti and G. A. Plizzari, Varenna-Leccho, Italy, pp. 945-954.

Hedebratt, J. (2003a). *Integrated Design and Construction of Industrial Floors – New design of Suspended Pile Supported SFRC Slabs – Arch Action in Industrial Floors*. Proceedings of the Nordic Mini-Seminar on Fibre-Reinforced Concretes, Design Rules for Steel Fibre Reinforced Concrete, Veidekke ASA, Skøyen, Norway, October 6th 2003, 6 pp.

Hedebratt, J. (2003b). *Praktikfall - integrerad projektering och produktion av industrigolv*. Swedish Cement and Concrete Research Institute, CBI's Informationsdag, 2003. 6 pp. (In Swedish).

Hedebratt, J. & Silfwerbrand, J. (2003) *Integrated Design and Construction of Industrial Floors - Instrumented In-Situ Studies on Differential Shrinkage*. Proceedings of the 5th International Colloquium on Industrial Floors, Ostfildern, Germany, 21th-23th January, 2003, Vol. 1, pp. 1043-1047.

Hedebratt, J. (2002) *Integrated Design and Construction of Industrial Floors - Demands on industrial floors and a pilot study on shrinkage strain*. Proceedings of the XVIII Symposium on Nordic Concrete Research, Helsingør, June, 2002, 3 pp.

Reports

Hedebratt, J. (2003b). *Integrated design and construction of industrial floors – Pilot study I*. Report 69, TRITA-BKN. Department of Structural Engineering, Royal Institute of Technology, 2003, 79 p. (In Swedish).

Hedebratt, J. (2001). *Integrated design and construction of industrial floors – Demands on industrial floors*. Report 64, TRITA-BKN. Department of Structural Engineering, Royal Institute of Technology, Stockholm, 2001, 95 p. (In Swedish).

Other publications

Silfwerbrand, J., Hedebratt, J., et al. (2008). *Industrial Floors – Recommendations for Design, Material Selection, Execution, Operation and Maintenance. (Industrigolv - rekommendationer för projektering, materialval, production, drift och underhåll)*. Edition 1, Concrete Report No. 13, Swedish Concrete Association Stockholm, Sweden, 2008. (In Swedish).

Nord T. & Hedebratt, J. (2006). *The creation of a lean construction enterprise and the role of the change agent*. Per reviewed article in doctoral symposium on Lean Construction, held by Division of Structural engineering, Luleå University of Technology, Luleå, 2006.

Hedebratt, J. (2003) *Integrerad projektering och produktion av industrigolv*, *Bygg & Teknik* 3/03, pp. 60-74. (In Swedish).

Table of Content

SUMMARY AND REVIEW OF THESIS	1
Introduction	3
1.1. Background	3
1.2. Objective and scope of research	6
1.3. Limitations	7
1.4. Outline of the thesis	7
1.5. Thesis contribution	7
Material aspects of structural SFC	9
2.1. Steel fibre concrete - a structural building material	9
2.2. Vital characteristic properties	13
2.3. Construction with SFC	19
2.4. Test methods and standard test methods for SFC	22
Pile supported slabs - the design matters	31
3.1. Standards and guidelines used in design and construction	31
3.2. Design of pile supported slabs and flat slabs	36
3.3. Failure mechanisms and serviceability conditions	42
3.4. Time-dependent properties of concrete and fibre concrete	48
3.5. Previous studies on pile supported slabs and flats slabs	49
The research work	67
4.1. Introduction	67
4.2. Description of the working process	67
4.3. Summary of appended papers	69
Conclusions and suggestions for further work	73
5.1. Conclusions	73

5.2. Earlier suggestions for further work	75
5.3. Suggestions for further work	75
Bibliography.....	79
APPENDED PAPERS	93
Paper A - Damages in Industrial Concrete Floors.....	
Paper B - Lessons Learned-Swedish Design and Construction of Industrial Concrete Floors....	
Paper C - Full Scale Test of a Pile Supported Steel Fibre Concrete Slab	
Paper D - Time-Dependent Deflection of Pile-Supported Steel Fibre Concrete Slabs - Full-Scale Test	
APPENDED TEST RESULTS, CALCULATIONS AND PICTURES	
Appendix A	
Summary of appended testing.....	

Part I

SUMMARY AND REVIEW OF THESIS

Chapter 1

Introduction

1.1. Background

The quality of industrial floors has for long time been an Achilles' heel in the building of industrial premises, including shopping centres, warehouses and buildings for logistic purposes and manufacturing and other range of applications.

Also for office and residential buildings and other applications in which large flat slab structures are constructed on the ground, supported on piles, above other foundations and constituting floors of buildings the failure and cracking behaviour has often been a troublesome concern for customers, contractors and designers. In 2004, the use of industrial flooring in Sweden was about 2 million m² per year (Hedebratt, 2004). Also the damages reported have had a constant trend during the last 30 years according to figures from Johansson (2003). In 2011 the building of industrial floors was in level of 2.5 million m², an increase with 25 % compared with 2004 that seemed to be a low notation.

Historical review on the project

In year 2000 funding was granted by The Development Fund of the Swedish Construction Industry (SBUF) to perform a pilot study on industrial floors. In January the pilot study started focusing on the demands on industrial floors. In December 2001 the study was presented in a report by Hedebratt (2001). In 2002 SBUF and Sven Tyréns Foundation granted funds for postgraduate studies. In January 2002 three pilot studies were started, the first one was presented in a technical report (Hedebratt, 2003) and the two second studies were condensed in the licentiate thesis by Hedebratt (2004), which was defended in February 2005.

The second part of the postgraduate studies started in January 2005; it involved extensive and unique but costly full-scale testing. This part has mainly been financed by Sven Tyréns Foundation and KTH, also some financial and material contributions is from different material suppliers e.g. Bekaert Building Products and Modern Betong and one of the larger

flooring contractors AB Linotolgov. Bekaert has also supported with extensive testing in the laboratory in Belgium and with x-ray photographing of test specimens (se Appendix A).

In year 2004 *Swedish Concrete Association* (SCA) appointed a committee to write a State of the Art and recommendation report on current knowledge on industrial concrete floors, new discoveries from research and experiences from using the norms and standards that have been established. This resulted in a comprehensive report in year 2008, *Industrial Concrete Floors – Recommendations for Design, Material Selection, Construction, Operation and Maintenance* (2008). Hedebratt and Silfwerbrand were involved as secretary and chair in the working group for the report *Industrial Concrete Floors*.

During the years 2007, 2008 och 2009 full-scale tests were executed in Västerås, Sweden. Before that a number of possible full-scale testing sites and models were evaluated and rejected. An elevated flat slab was however cast, to the first half of fibre concrete and to the second half as reinforced fibre concrete (i.e. combined reinforcement). This was to simulate the structural principle *pile supported slab*. Dependent on the application and on the load level, the elevated slab could model either half or full-scale of industrial floor slabs. The short-term tests were executed until failure in parts of the slab, with beginning in the spring of 2008. Thereafter a one year long-term loading subsided.

In year 2010 and 2011 funds were granted by Sven Tyréns Foundation, SBUF, KTH and the Swedish Cement and Concrete Research Institute to analyse the measurement studies and to write this thesis. In 2011 the final test results were received regarding the tested material properties.

Present status of building trade

First quarter of 2011 there were 500 building permissions granted for premises, which was as in level of the first quarters of the years 2009 and 2010, with the difference that the built area had increased from 600 000 m² in 2009 to 625 000 m² in 2010 and to 878 000 m² in 2011. For the hole of 2010 there were granted permissions for building 2 596 000 m² of premises. The top notation for number of granted building permissions was for year 2007 when 2 939 building permits were granted for a total area of 3 220 000 m².

A trend is that the number of granted buildings permits is lesser and that the areas built are larger. In spite of the fact that the number of granted permits from the year 2002 to 2011 has decreased with 25 % from 3 150 to 2 360 building permits, the gross building area has not decreased to any appreciably extent. From 2 537 000 m² in year 2002 to 2 445 000 m² in year 2011, a reduction with 4 %. These conclusions are drawn from statistics in *Statistics Sweden* (SCB) *Year book* (2011).

Another indicator is from the trade association the *Commission on Pile Research*. The Swedish piling contractors have reported that 2.15 million meter piles have been installed in 2010. This is a strong rise since the previous year with an increase of 620 000 metres. In Figure 1.1 it seems to be a percentage decrease for usage of steel piles in industrial buildings. The trend is not so obvious when comparing the figures in Table 1.1 and 1.2 and Figure 1.1. The overall trend since the mid 1990's shows a steady increase with a small drop in 2009, see Figure 1.2.

1.1. BACKGROUND

Table 1.1: The distribution in steel piles on type of building. Reproduced fact from Commission on Pile Research, information 2011:1 (2011).

Year	2010	2009	2008	2007	2006
Residential housing	25%	28%	34%	33%	38%
Other house buildings	27%	26%	20%	28%	25%
Industrial buildings	16%	17%	20%	22%	23%
Road constructions	32%	29%	26%	17%	14%
	100%	100%	100%	100%	100%

Table 1.2: Thousands of meter steel piles. The distribution on type of building. Reproduced fact from Commission on Pile Research, Information 2011:1 (2011).

Year	2010	2009	2008	2007	2006
Residential housing	159	151	270	240	209
Other house building	171	140	159	204	138
Industrial buildings	101	92	159	160	127
Road constructions	203	157	206	124	77
	634	540	794	728	551

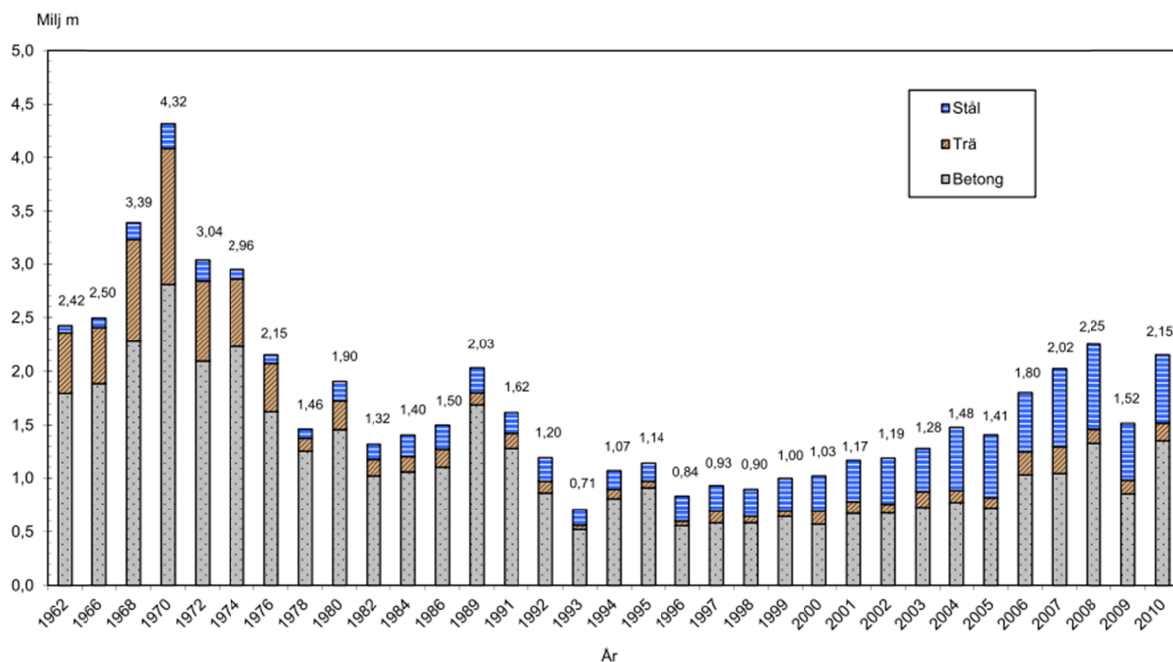

Figure 1.1: Statistics on piles from the major piling contractors in Sweden 2010 reported since 1962 Total number of installed piles distributed on different construction materials. Stål = steel, trä = timber, betong = concrete. From Commission on Pile Research, (2011).

You could suppose that the increase of number of pile supported floors is large. In attractive areas with good ground conditions suited for foundations directly supported by ground there are already established settlements and new buildings are therefore referred to ground that is in need of pile supported foundations. Any exact numbers on the part of floors where steel fibre concrete is used for pile supported floor slabs is not existent, however in 2004 the figure was estimated to be around 20 % for Sweden (Hedebratt, 2004).

The author's opinion (and opinions from questioned floor contractors) is that the market share of pile supported floors is increasing. Hedebratt has also noticed that contractors have started to build in areas that are in need of pilings, sometimes with the ground as the only support. Also the ground where piling is used seems to be more water saturated and of lower strength (i.e. old sea bed) not even suited for pile supported floors due to risk of ground settlements in early construction phase. As the market tendencies to be more hazardous and risk taking, the guiding principles in the report *Industrial Concrete Floors* may be in need to be elucidated and to be further developed.

National financial incitements for building balance

Also in residential and office building there is a need of fast and price worthy building materials and methods. The since long time neglected housing market in Sweden is currently in need of cheaper and faster building methods. This can be concluded from facts from The *Swedish Construction Federation* (BI) that reported that only 17.500 dwellings were anticipated to be built in 2010 whereas the production should be 40.000-50.000 dwellings per year. About 1.2 million young people are waiting for a place to live in the near future due to a large young age group (Glans et al., 2009). In the main Swedish cities only fractions of the needed dwellings are built per year, this is verified with data in *Statistics Sweden* (SCB) *Year book* (2011). Steel Fibre Concrete (SFC) is a promising material that could very well be used to minimize the building costs for residential and public buildings in the near future.

1.2. Objective and scope of research

The postgraduate research project as a whole aims to develop methods to increase the quality of industrial floors in the production phase. With the licentiate thesis an integrated methodology for design and production was developed. The second part of the project has as outermost purpose to proceed to increase the quality on industrial floors but has a specific focus on studies on pile supported steel fibre concrete slabs including actions, structural behaviour and development of design rules for the same.

The research project has a goal to form a better basis and reduce risks for involved actors in the building of pile supported floors. A development of the building process for pile supported floors with a more rational reinforcement method implies that the structure still shall be capable of function. Functional based designs of reinforcement and fibre concrete shall also be profitable in production.

Calculations on business possibilities on steel fibre concrete and reinforced steel fibre concrete each contractor could do, this is not in focus for this research project. The project increases the possibilities for contractors and clients to develop their enterprise and for a larger number of designers to accomplish trustworthy and reliable design calculations with reduced risk for the contractors.

The verification of the function has hitherto only been possible to do with full-scale testing. For current type of structure and material selections and loading the full-scale testing is unique.

1.3. Limitations

It is not the aim to study flats slabs and slabs that are not constructed on ground (i.e. elevated slabs) even if the design principles in general is the same or similar. The difference is actually minimal regarding function and design but design of additional structural elements and details such as connections and support structures and used reinforcement principles differs essentially and the safety level is sometimes higher in these structures.

1.4. Outline of the thesis

This thesis consists of an extensive summary and four appended papers. Significant results are presented in the papers and additionally data and material testing are presented in appendices. The papers may be read separately but the reader may have a larger understanding of the thesis and the papers if reading them in chronological order.

1.5. Thesis contribution

The thesis is valuable for the contractors that can take advantage of increased capacity and more valuable concrete floors. Through increased understanding on the behaviour of fibre concrete and pile supported floors in short and long term loading safer design calculations could be performed. This results in decreased risk taking for contractors, material suppliers and consultants.

Beyond the benefits for designer, contractors and of course material suppliers the benefits is for clients and end users of industrial floors through a more economical building and reduced risk with reliable design directions. For some clients the cost of the building is an expense that will be re-covered in short time, much shorter than the buildings life. The actual functionality is then of greatest importance and a reduction of functionality may cost several time the total building cost. In a recent project the author was involved in the owner of a medical industry should re-cover the total building costs in a couple of month, hence then that the functionality of the floors were important.

In the case a university building program includes courses on fibre concrete the results from the thesis will be involved.

Chapter 2

Material aspects of structural SFC

2.1. Steel fibre concrete - a structural building material

Structural use of FRC

In the purpose of controlling cracking steel mesh reinforced concrete has often been exchanged with steel fibre concrete (SFC) or steel fibre reinforced concrete (SFRC), this has also been the main application for SFC. The abbreviation SFC is more modern and preferred by the technical committee SIS/TK 556 AG 1 FRC Design instead of the abbreviation SFRC, as the fibres are randomly mixed with the concrete material as a component of the material behaves as a material with changed properties. Also in Swedish design the addition of fibres is theoretically treated as part of the material properties rather than a defined strengthening component in the structure.

The abbreviation RSFC could and maybe should be used for reinforced steel fibre concrete i.e. a combination of steel bar or steel mesh reinforcement and steel fibre concrete which is more logical. Also steel fibre reinforced RC is commonly occurring in the literature when the main strength is from traditional reinforcement. Other combinations occurs for example when high strength HS or ultra-high strength UHS or high-performance HP is used in combination with self-compaction concrete SCC. The alphabetical abbreviation HSFRSCC is often used in literature for an intended superior material. At least the research presented from the beginning of this millennium and on regards SCC they often came with a twist. The principle behaviour of NCC (VCC) and SCC are the same except the compaction (normal compaction, vibrator compaction or self-consolidation) part.

There are however some minor differences in e.g. bond-slip and residual strength and softening and hardening behaviour due to higher contents of fine material and binders in SCC thus increasing the gluing affect. Also micro fillers e.g. micro silica improves the bond and increases the pull-out load for fibres. See Bentur et al. (1995), Chan and Li (1997), Rasmussen (1997), Banthia (1998) and Chan and Chu (2004). Wongtanakitcharoen and Naaman (2004) have also shown that the mechanical properties of SFC are changed over time

and the chemical bond (adhesion) was insignificant in early ages but increased from about 8 hours to 24 hours. In series of books by Bentur & Mindes (2007) can also be read that the filler induce the slip hardening behaviour which is also influenced of the shape of the fibre.

The performance properties of concrete are often considered to have varying importance between different countries and have therefore different focus, see e.g. Døssland, (2008). In Sweden normal strength concrete with added fibres are not considered as high-performance, even if that in fact could be the case. Also in the work described in Paper A – Paper D, appended in the thesis, and the research work behind only normal strength SFC was used. However in this thesis several abbreviations are used dependent on what other researcher us as abbreviation, explanations is made if needed.

Fibres for use in structural fibre concrete and composites

Although, for FC structural applications bending is most dominant and the flexural behaviour of steel fibre concrete is apparently considered.

The European Standard EN 14889-1:2006 (CEN, 2006) defines and gives requirements on steel fibres for non-structural or structural use. It declares that steel “*fibres are straight or deformed pieced of cold-drawn steel wire, straight or deformed cut sheet fibres, melt extracted fibres, shaved cold drawn wire fibres and fibres milled from steel block which are suitable to be homogeneously mixed into concrete or mortar*”. Moreover, in that norm, steel fibres are divided into five general groups and are defined in accordance with the basic material used for the production of the fibres according to:

- Group I: cold-drawn wire;
- Group II: cut sheet;
- Group III: melt extracted;
- Group IV: shaved cold drawn wire;
- Group V: milled from blocks.

Fibre materials other than steel are considered to have too low strength or having far too low elastic performance i.e. the Young’s modulus of elasticity is low. As comparison steel has ten times higher elastically response than most synthetic materials used in fibres for concrete.

Also other factors like coefficient of temperature expansion α is similar for steel and concrete and the durability of steel embedded in concrete is good due to for steel protective alkali environment. The steel is sometimes but seldom stainless (A1 – A4) if needed due to harsh chemical attacks (commonly acid or saline environments).

Many other fibre materials as carbon, polyolefin, polyester (PE), poly-ethane, (PET) poly-propylene (PP), poly-vinyl-alcohol (PVA), asbestos, glass, etc. have more or less desired properties useful in some applications but utterly not suited to be mixed in concrete for structural applications were stress re-distribution or crack width control is needed, instead

2.1. STEEL FIBRE CONCRETE - A STRUCTURAL BUILDING MATERIAL

used in applications where the early drying shrinkage often is most dominant. Properties of different types of fibre material have been listed by e.g. Löfgren (2005), Døssland (2008).

Fibres are also used for preventing fire spalling, and then PP fibres are used see e.g. Jansson (2008) and SCA (2011). Examples of natural fibres used as matrix reinforcement are wood, cellulose, bamboo, elephant grass, hay, and horse hair. Also oil palm trunk has been researched on by Singh et.al. (2010). One of the oldest known fibre composite high-rise structures is the skyscrapers in the old city of Shibam (Yemen) built in the 3rd and 4rd century AD, where the people continuously must add new layers of natural fibre clay. Here the whole super structure including slabs on beams are constructed with a fibre material.

Fibres materials are also used to strengthen concrete on out-side of structural sections see e.g. Täljsten (1994) and Wiberg (2003) thus out-side the scope of this thesis.



Figure 2.1: World Heritage, Shibam, Yemen, the oldest skyscraper city in the world. Constructed with fibre reinforced mud bricks in the 3rd and 4rd century AD was built in 5 to 9 stories high. Photo: © UNESCO.

Load carrying flat slabs – where the support does not come from the ground directly i.e. where the support comes from piles or culverts, columns or walls – are commonly regarded as structural concrete structures. Even if not a crucial member for the bearing system of the building, the ground slab is often used as a structural support that with its huge mass links the orces to the ground. Foundation slabs, pile supported floors and elevated flat slabs are interesting to construct with SFC due to traditionally high reinforcement ratios.

To increase the calculated load bearing capacity of SFC structures and to obtain and secure stiffness in the cracked concrete, structural reinforcement and stirrups still often consist of steel bars. Several researchers have shown that the addition of fibres to concrete increase the flexural stiffness and also the shear resistance and possibilities to be used in the anchorage zones of pre-stressed structures and for some of the conventional reinforcement in house frames, see e.g. Noghabai (1998), Gustafsson et al (1999), Groth (2000), Hedebratt (2000), Salomonsson (2002) and Dössland & Kanstad (2005).

The future for SFC

Also bridges and other slab structures could gain from or be built with SFC or steel fibrous cement based composites (SFCBC) according to the thesis of Ay (2004). However these fibre composites are near the cutting edge of what may be replicated in laboratory environment.

Löfgren et al. performed full-scale experiments on beams, made of self-compacting fibre reinforced concrete, the test was also complemented with material testing (three point bending test 3PBT and wedge splitting test WST). After inverse analysis where he could conclude that:

“The result indicates that FRC can be used in combination with low reinforcement ratios; the amount of reinforcement could be reduced to half that of conventional reinforced concrete (for the same load-carrying resistance) but still lead to improved structural performance (reduced crack width and increased flexural stiffness).” (Löfgren, 2005).

New types of fibres and concretes that better suit structural applications are needed for the SFC to blossom out for real another obstacle is how the material is treated in the design codes and standards (see chapter 2.4 and 3.1). Still the main part of existing fibre types and brands used in SFC only designs give softening properties when produced in current concrete plants with mix design inside economical frames. These types of SFC will probably be used also in the future in combination with conventional reinforcement whilst for SFC only and in structurally advanced designs a refined SFC (developed fibres and concretes and composites) where the non-linear behaviour is utilised in higher degree.

These are very interesting features and properties of SFC for a designer to deal with and to use in structural designs. The future in this would be less reinforcement compared to present designs and accordingly savings for contractors and the environment in line with green building philosophy.

2.2. Vital characteristic properties

Tensile hardening and softening behaviour of mature SFC

The most characteristic material behaviour for SFC is shown after reaching the limit of what the material may contribute in elastic condition. This limit is commonly referred to as the limit of proportionality LOP and where SFC starts to show a residual strength after this post – peak failure. To utilise the residual behaviour it must be confirmed for each material composition. Either the post-peak behaviour is determined from uniaxial tension test where the fracture toughness is used to characterize the material or the SFRC is tested in bending to determine the flexural toughness properties. This testing has been proven to be complex which also is easily understood. To sum up some of the entrapments, I quote one of my former colleges Patrik Groth who was Ph.D. candidate when I took my classes in civil engineering:

“The fracture toughness may be expressed by fracture energy, characteristic length or critical energy release rate etc. which are considered as material properties defining the fracture mechanics properties of a tension-softening material. The flexural toughness on the other hand is a result of the fracture toughness of a specific material tested in bending. Therefore, the flexural toughness could never be regarded as material property and the results are affected by such factors as; specimen size and geometry, loading conditions and evaluation technique etc. Due to this fact it is necessary to use standardised methods to obtain the flexural toughness.” (Groth, 2000).

Naaman has since the mid-1980s used the term “high performance” to describe “strain-hardening” FRC composites. He used the following definition: *High performance fibre reinforced cement composites are a class of FRC composites characterized by a strain-hardening behaviour in tension after first cracking, accompanied by multiple cracking up to relatively high strain levels.* (Naaman, 1985), (Naaman, 2007).

Strain-hardening occurs when the plastic strength properties are higher than the elastic strength properties after the limit of proportionality LOP, see example curves in Figure 2.2. The definition of hardening behaviour says that *the stress curve at prolonged loading exceeds the cracking stress*. Then it must have a gradual ascending trend where $(df_{ct}/d\varepsilon > 0)$.

The SFC strain and bending hardening behaviour and its necessity for structures has been investigated by e.g. Tjiptobroto & Hansen (1991), Löfgren (2005).

Contrary to strain-hardening, softening materials have a gradual descending trend $(df_{ct}/d\varepsilon < 0)$, after the limit of proportionality LOP, where the SFC shows plastic properties. In a strain-softening SFC only one crack develops whereas for strain-hardening SFC multiple cracks may be formed. For structural use of SFC, strain-hardening $(df_{ct}/d\varepsilon > 0)$ and bending hardening $(df_{cb}/d\varepsilon_b > 0)$ properties are of course anticipated to be beneficial but this often means a dense fibre distribution which may be difficult to obtain at concreting.

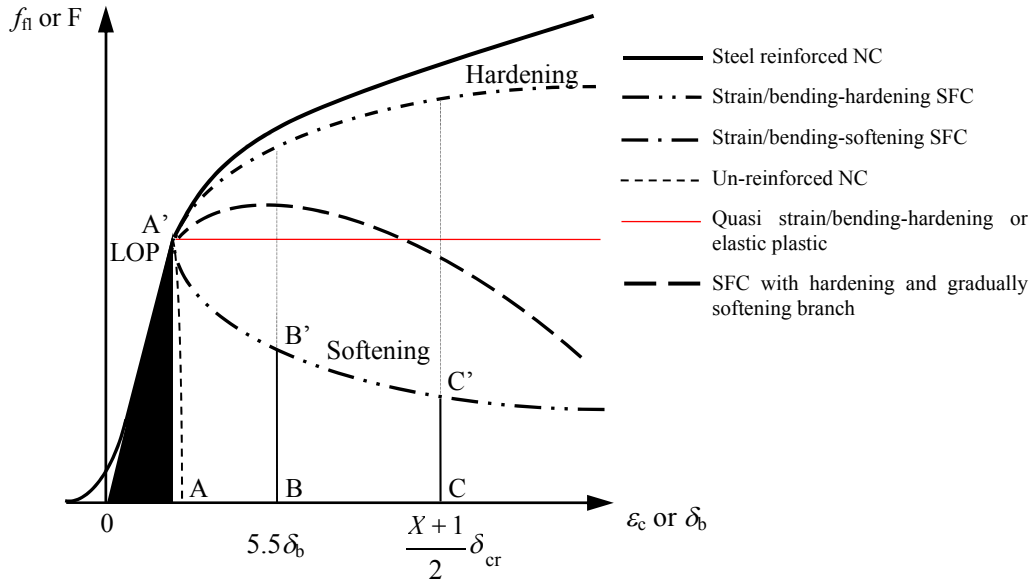

Figure 2.2: Idealized properties of a prismatic beam made of steel fibre concrete (SFC) exposed to tension/bending compared with reinforced and un-reinforced concrete (NC) in principal. Either in tension the stress/strain f_{fl}/ϵ_c or in bending the force/deflection F/δ_b relationship is used. Adjusted graphs in principle from *Swedish Concrete Association, (SCA) Concrete report no 4 (1997)*.

A strain-hardening concrete slab should not have problem with cracking implied by Figure 2.2 which in turn implies that strain-hardening SFC is suitable for load carrying structures that allow for crack distribution i.e. statically indeterminate structures.

Definition of residual strength

The properties of SFC are often defined by a residual strength. i.e. the flexural crack strength times a residual strength factor according to Equation 2.1.

$$f_{fres} = f_{flcr} \cdot R_{10, X} \tag{2.1}$$

In Sweden the residual strength factor R with toughness indices I_{10} and I_X is used to determine $R_{10, X}$ according to Equation (2.2). The residual strength factor with toughness indices describes the mechanical properties after the first crack of a prismatic SFC beam in 4-point bending.

The area of the force/ deflection curve diagram inscribed by the elastic part and the curve after the first crack deformation δ_{cr} (the plastic part) and the deflection axis (Area =0A'B'BA0 see Figure 2.2) divided by the area inscribed by the elastic part and the vertical force axis and the deflection axis (Area 0A'A0, see Figure 2.2) in the two deflection intervals $5.5 \delta_{cr}$ (for I_{10}) and $(X+1) \delta_{cr} / 2$ (for I_X). Normally $X = 20$ and $X = 30$ is considered even though other X -values could be used. Taking account of the hole curved line gives more

2.2. VITAL CHARACTERISTIC PROPERTIES

accurate values of the residual strength factor in Equation 2.2, from *Swedish Concrete Association* (SCA), Concrete report no 4 (1997).

A more simplified evaluation method is given by Silfwerbrand (1995), where the quota of the crack strength and the mean values of the residual strengths at the desired deformation intervals are calculated.

A SFC with a high value of the initial toughness index, i.e. $I_X = 20$ or with X less than 20, shows better crack redistribution due to a tougher earlier response while a SFC with a high toughness index $I_X = 30$ or determined for higher X values show better moment capacity due to a tougher response later at the stress/strain curve.

$$R_{10,X} = 100 \cdot \frac{I_X \times I_{10}}{X - 10} \quad (2.2)$$

In some European countries e.g. Great Britain, the Japanese toughness factor $R_{e,3}$ is used, related to the mean value of the bending tensile stress until a deflection of 2.5 mm of a prismatic beam in 3-point bending. See chapter 2.4.

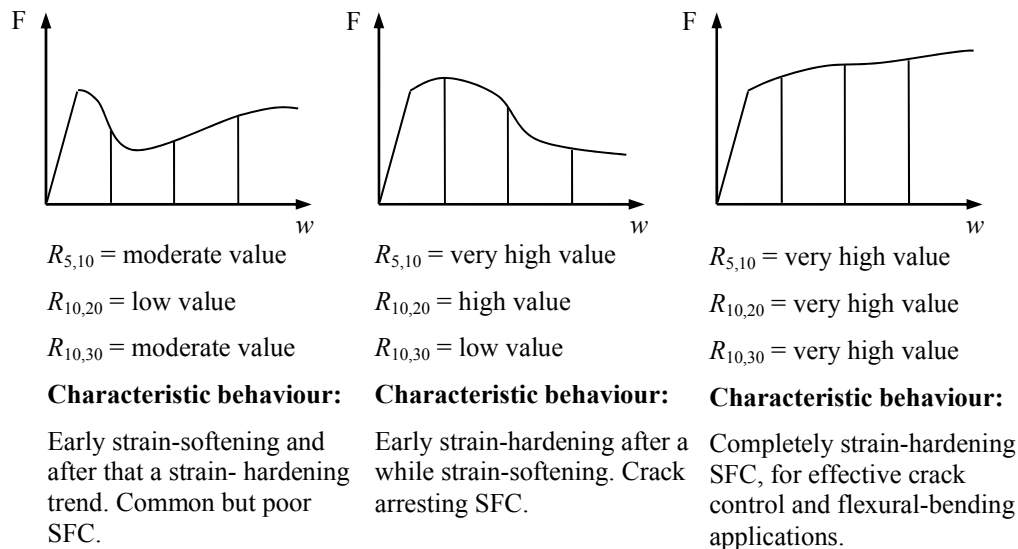

Figure 2.3: Principal use of residual strength parameter and toughness indices, more combinations may occur.

Residual strength and fibre dosages

To be able to obtain crack arrestment with SFC the steel fibre content usually is between 35 and 50 kg/m³, this correlates to a residual strength factor $R_{10,20}$ or $R_{10,30}$ of 60 to 80 %

depending on the mix design of the concrete and the fibre type. For examples of fibre types see e.g. *Swedish Concrete Association* (SCA), Concrete report no 4 (1997), however only a few of the fibre examples are used in current building and as more advanced forms and materials have been developed also better performance is expected.

A completely crack controlling SFC is regarded to be strain hardening which means that the residual strength factor $R_{10,X}$ is in excess of 100 %. This normally correlates to steel fibre contents from 60 kg/m³ or more even if there are no exact values and impossible to predict without the experience of testing the actual SFC.

Sandbakk (2011) has shown that already 0.7 vol. % (ca. 55 kg/m³) Dramix RC-65/60-BN fibres may be sufficient to show hardening behaviour in bending when testing according to NS-EN 14651.

Shear resistance in beams and slabs

For beams the high shear resistance of steel fibre concrete (SFC) and reinforced steel fibre concrete (RSFC) is a favourable material property. The in Sweden most often used solution is from Narayanan & Darwish (1987) as suggested in *The Swedish Concrete Association, Concrete* (SCA) report No 4 (1997) and Concrete report no 13 (2008). The shear resistance of fibre concrete is mainly due to fibre bridging and dowel effect. It has been shown that the shear resistance in reinforced concrete beams can be increased with up to 100 %, see e.g. Swamy & Bahia (1985), Narayanan & Darwish (1987), Kaushik et al. (1987), Murty & Venkatacharyula (1987), ACI Committee 544 (1988), Ashour et al. (1992), Saluja et al. (1992) and Shin et al. (1994). According to the research the shear resistance (with at time available fibres tested) was increasing up till about 1 vol. % where an optimum was found.

A recent master thesis at KTH, (Mondo, 2011), has analysed a large number of beam tests that have been subjected to shear loads. She suggests using the Italian proposal in CNR (2006) among the others investigated, i.e. Narayanan & Darwish (1987), DafStB (2010) and Rilem (2003).

Khanlou et al. (2012) found that steel fibres with a dosage of up to 80 kg/m³ enhance the ultimate shear capacity of the concrete up to 70 % compared to plain concrete shear capacity. It was also observed that ultimate shear capacity of SFRC, with fibre dosage above 40 kg/m³, was higher than cracking shear stress.

“The FIP shear test method was successfully used to obtain the shear performance of the SFRC and plain concrete. The results demonstrate that the addition of steel fibres of as much as 20 kg/m³ changes the failure mode from brittle failure to a ductile failure. This means that the material can sustain significant loads after cracking. The improvements in shear strength of SFRC were more significant for steel fibre dosages above 40 kg/m³ (0.5% fibre volume fraction), in both normal and high strength concrete. An empirical model was derived, based on regression analysis, to predict the shear strength of SFRC specimens.” (Khanlou et al., 2012). For the FIP shear test see Figure 2.5.

Also De Hanai et al. (2008) concluded tests on beams and slabs: *“Based on the experimental results, it can be concluded that there are unequivocal similarities between punching shear strength in flat slabs and shear strength in analogous beams. The analogous slabs and beams*

2.2. VITAL CHARACTERISTIC PROPERTIES

must have the same height, longitudinal reinforcement ratio and concrete properties. Therefore, shear tests on small prismatic beams can be performed to get useful indicators for the steel fiber reinforced concrete mixture design, looking at its application in flat slab-column connections.” (De Hanai et al., 2008)

For pile supported slabs the influence of steel fibres on shear resistance will increase the bearing capacity in punching and shear of point loaded slabs. See e.g. Maya et al. (2012).

Localization of cracks

A phenomenon that occurs in strain-softening SFC is localisation of cracks i.e. one single crack is developing when the structural material has reached LOP. For a pile supported slab this failure will occur, if no other influencing factors, e.g. restraining friction to the ground or piles, exist.

The fibres bridging the crack will be subjected to pull-out due to lost anchoring or yield and finally break due inadequate fibre strength or tensibility (a) in Figure 2.4.

A similar failure may also occur for a strain-hardening SFC, if there exists a weak zone that only few fibres bridge, i.e. the fibre distribution is not sufficient, and then the distributed stresses cause multiple cracking but also strengthen the stronger zones and thereby reveal the weak zone with a localised crack. Localization of cracks can be read about in e.g. Groth (2000), Löfgren (2005), Naaman (2007).

Localization of cracks probably also occurs in SFC slabs at punching failure. In the full-scale test described in **Paper C** two failures resulted in punched out cones, when increasing point loads were applied in the middle of two panels of an elevated slab. The failure was not entirely round but rather oval shaped and had an uneven failure surface.

In experiments with combined reinforced SCCSFRC beam specimens Schumacher et al. (2009) have shown that the localization of deformations in one crack results in the observation that the total deformations at failure are smaller for specimens without fibres where localization occurs in several cracks.

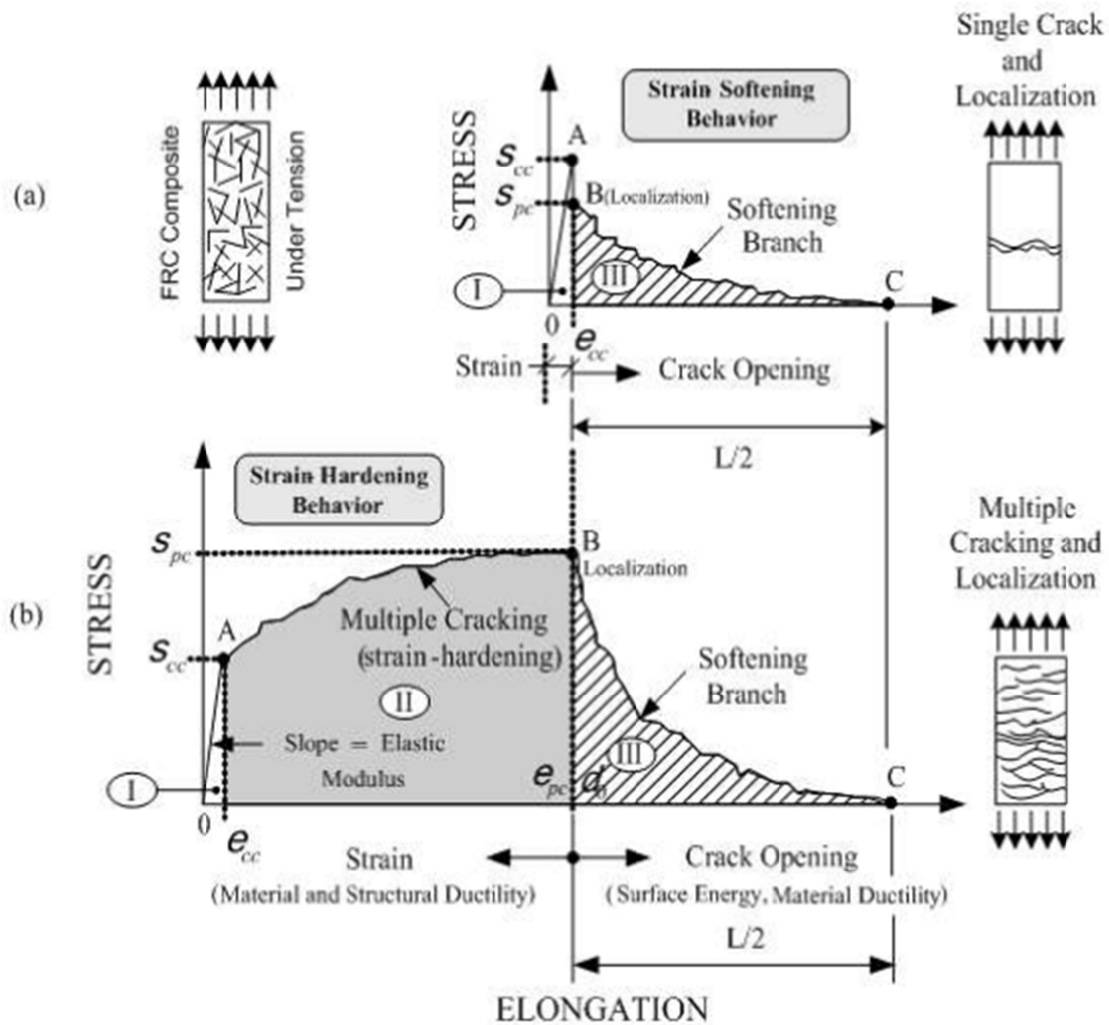

Figure 2.4: Principal cracking behaviour when the fibre concrete specimen are subjected to stress–elongation. (a) Strain-softening behaviour. (b) Strain-hardening behaviour (HPCFRCC). (Naaman, 2007)

The crack localization will for slabs occur in the predominant yield lines. Figure 2.5 could be compared with the yield lines that were due to loadings in **Paper A** and **Paper B**. In Figure 2.5 (right hand side) the cracked slab is simply supported on four sides, for the full-scale test slab there was a mixture of support conditions between each slab panel (simply supported, clamped or continuous). Hence the crack pattern will not look all same.

However, in case of a higher dosage the slab behaved highly *bending hardening* similar to the bottom right illustration, also resulting in a dense pattern of smaller cracks. In the top surface the visible cracks were few, actually only one circular crack for the clamped-in corners. Hence only one small crack was localized and there was believed to be a multiple but very dense pattern of micro cracks that could not be seen with the naked eye.

The right upper illustration shows in opposite to the slab illustrated below only one crack in the bottom of each yield line. A similar crack pattern occurred with larger localized cracks in the tested slab panels. In the top surface several larger cracks developed as the loading increased.

For the figure to be correct the cracks is shown in the bottom of the slab and no visible cracks are observed in the top surface in equality of the bent beam in the two middle illustrations.

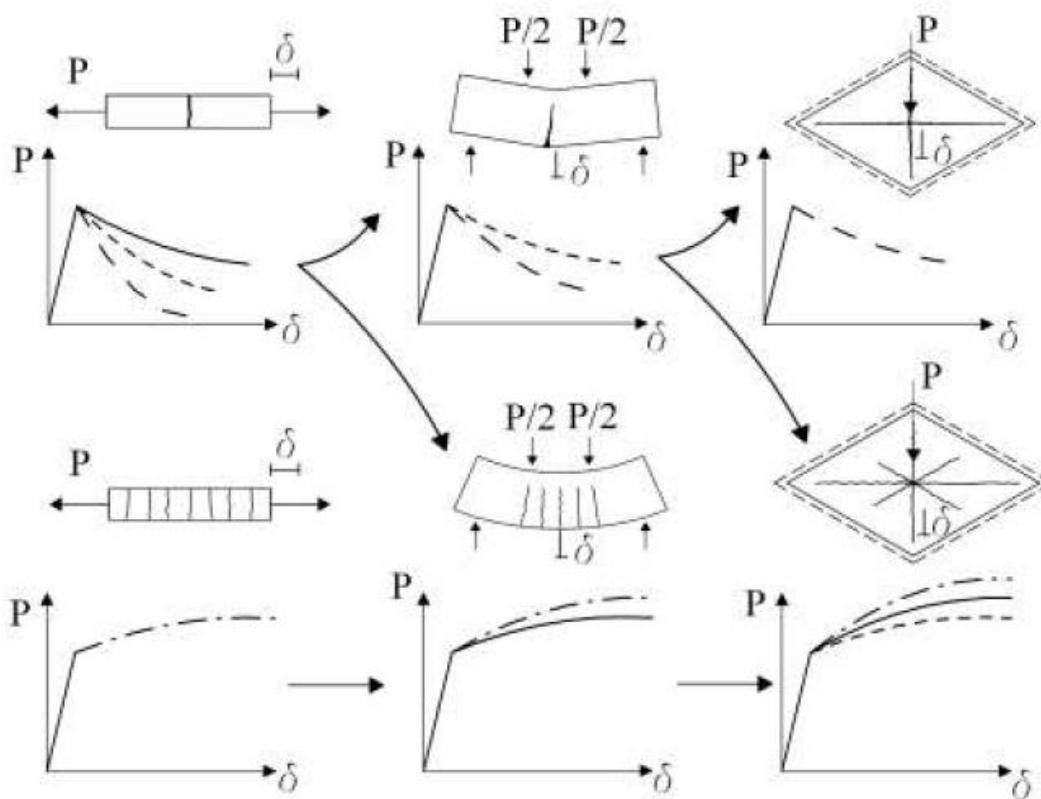

Figure 2.5: Different response of structures made of FRC having a softening or hardening behaviour under uniaxial tension or bending loads. (From fib Model Code 2010)

2.3. Construction with SFC

Main advantages with the use of SFC in construction

Obviously the use of SFC leads to less reinforcement work when all the main reinforcement is shifted out in favour to SFC. Still there is often a need of steel reinforcement bars to handle peak moments and shear in parts of the pile supported slab. As SFC is strong in shear a design calculation may also exclude part or all of the shear reinforcement in edge beams and often the slab will manage to bear in shear above piles if the pile caps are sufficiently large. This is

practical due to otherwise there would be a need of heavy or narrow spaced reinforcement in these structural details. Pile caps of SFC are often constructed in round paper moulds with a technique that is much less time consuming than traditionally reinforced square timber moulds.

The author has noticed that the time factor has often been a decisive criterion when choosing SFC in many building project. Including SFC in edge beam and other founding is often successfully made. Hence time is the most important factor when seeing at the total costs when building pile supported floors.

For applications more common for SFC the existing machine park in the concrete plants and currently used concrete mixes or similar mixes probably must be used to gain access to heavy structural concrete projects (i.e. where the concrete part of the project is of magnitude). This is because the ordinary concrete still has the main market share and the machine park will not be interchanged to fit SFC in first case. If the fibre performance is changed substantially and inherited in common designs by common designs material suppliers and contractors this could be a change agent for the concrete industry. Investment in developing the concrete plants and delivery systems could be of great fortune and success when the fibre standardisation is realised.

Engineered fibres

Future types of fibres will probably show higher toughness at less dosage as the development of fibres for different use is fast. This is indicated by the development of engineered fibres that has not only had its focus on enhancing the competitiveness on the narrow span market for strain and bending softening SFC i.e. slab on ground structures and tunnelling. Bekaert (2012) has recently developed and introduced fibres called Dramix 4D and Dramix 5D, that will show moderate level of bending softening properties at only half the fibre content or less than is normal or high degree of bending hardening for fibre dosages that is normal in present mix-designs. The so called 4D fibres should preferably be used in combined reinforced structures and 5D fibres should be used in structured with-out the addition of traditional reinforcement.

This fibre types with extra end hooks, higher tensile strength and larger deformation range are completely developed for use in structures (Lambrecht, 2012), (Vitt, 2012).

Research at the University of Michigan, e.g. Naaman (1998, 1999 and 2000), led to the development of new steel fibres with optimized geometry. Engineered fibres called Torex, also developed to be used in structures rather than in flat slabs.

“It is made of very high strength steel wire, polygonal in cross section (primarily triangular or square), possible having indented sides, and twisted along its length. The key feature of this fibre is that when it is pulled-out from a cement matrix, its resistance increases with increase in slip (the more it pulls out, the harder it resists).” (Naaman, 2003).

Pumping SFC

The need of flowable and pumpable SFC is constantly increasing. However in recent projects pumping SFC has been a problem; due to lack of suitable pump equipment. Modern concrete

pumps are rarely adapted for high fibre contents with long fibres and especially not in when the fibre dosages is high ($> 50\text{-}60 \text{ kg/m}^3$). Often the pump tray becomes clogged due to less good tray design for the flow of SFC that tends to build up stacks in flat tray bottoms. Still shorter fibres or less fibre dosage of longer fibres may have better flowing and pumping ability. The pumping issues are often solved at site with super-plasticisers, exchange of aggregates to smaller particles or increasing the cement and water content or a combination of the actions – which often is in un-favour for the quality of the final floor.

Addition of fibres to reduce fibre balling

A well-known problem with mixing fibre concrete has been the balling of fibres into small sticky hedgehog sized balls. This problem has been dealt with differently by different fibre suppliers. Slender and thereby high performance Dramix® fibres are added in glued flakes or by belts with special adding machines or manually added at the ready-mix plant. Other fibre suppliers instead choose thicker and less slender fibres that are added at higher dosages. Fibre balling may if not noticed give a dangerous fracture zone or surface damages and may clogging the concrete equipment e.g. pumps, mixers or laser screeders. If the fibre addition is careful or with fibre-dosing system balling is normally an un-existent problem and the fibre distribution show less scatter.

To control the fibre dosage the equipment is either controlled by load-cell only to weight the fibres or by integrating the system with the mixing computer. The accuracy for normal batches is $\pm 0.5\text{-}2.0 \%$. The accuracy is fibre dependent (Incite, 2012).

Trade-union

The workers and the trade-union often agree on that labour-intensive and heavy work should be minimised due to risk of injures and wear-out. When it comes to SFC, the response from workers and the union sometimes is different. A bonus payment, in Swedish called *Skott*, for reinforcement work performed, is often by kg steel reinforcement installed per day, the use of SFC often results in reduced total salary which does not delight every one.

Automatic construction

The use of automatic construction is often in favour of manual construction methods, see Hedebratt (2004). Using SFC only in the main part of concrete intensive building projects could speed up the construction time considerably and make the construction less laborious. The use of e.g. laser screed equipment often gives a quality improvement, and generally a more economical installation mainly due to increased production speed. This is however often hindered by need of reinforcement or placing of installations in the floor or near the ground surface.



Figure 2.5: Typical semi-automation of concreting of piles supported SFC floor slab with combined reinforcement in strips. In this sequence the laser-screeder is equipped with topping spreader. Still people must run the machines and bull-float and power floating the surface. Photo: Hedebratt (2001).

2.4. Test methods and standard test methods for SFC

Moment capacity

In Sweden the 4-point bending of prismatic beams according to *The Swedish Concrete Association*, Concrete report No 4, SCA (1997) has been the most common testing method. The method originates from the now withdrawn American test method formerly given in ASTM C1018-97 (using beams with third-point loading). The test method is sensitive for distortions in material uniformity and gives relatively large scatter if the test procedure including sampling is not followed thoroughly.

This has been seen as one of its favours from the designer's point of view (e.g. the author) as it exposes a poor SFC mix-design and an uneven fibre distribution. This is not always in the material supplier's interest and a concern of the contractors as there often have been difficulties to reach stated residual strength in material verification. The responsible or maybe a little bit conservative designer knows that the material production including mixing procedure and time and handling of SFC in transports must be stretched up in order to get approved test results. This then would give a total quality improvement. Acting like this may be a wrong way to handle these production issues. But the other way is to choose methods that always give a little better test results. Then do they really depict the material properties in the structure? For certain you would not find "labcrete" there and other measures to measure the distribution of the concrete turn out to be hazardous or at least laborious when the slab size is not 10 m² but 10 000 or even 50 000 m².

2.4. TEST METHODS AND STANDARD TEST METHODS FOR SFC



One other advantage is the theoretical treatment of the maximum ($= 0$) moment as shear has its minimum between the two loaded points and therefore is supposed to have no disturbing effect on the failure load. The test is only valid if the crack appears in this part as shear failure otherwise would interfere. See e.g. SCA (1997), Löfgren (2005), Døssland (2008).

The SS-EN-10651 test standard is inherited from the work in Rilem 162-TDF. The Rilem 3-point bending test with a notched prismatic beam has shown to produce testing with lower scatter than the un-notched beam test methods. , Löfgren (2005), Døssland (2008).

Both the un-notched 4PBT according to SCA and the notched 3PBT according to the SS-EN-10651 test method are recognised as proven and recommended by SCA (2008). See Table 2.1 for examples on test for steel fibre concrete. Some of them are more suited for precast elements or shotcrete.

Comparisons between round determinate panels supported on three points (developed by Bernard, see e.g. Bernard (2000), Bernard et al. (2002)) and the Rilem 3PBT have been made by Dupont et al. (2004). They found that the scatter was lower for the round panel test according to ASTM C 1550 02 than for the Rilem 3PBT. However they also found that there are no design parameters provided from the test, but the yield line theory could be used to predict the results with reasonable accuracy. (Dupont, et al. 2004)

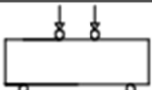
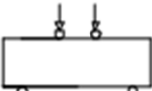
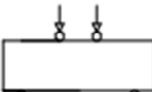
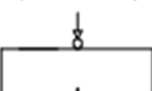
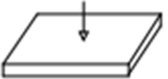
Table 2.1: Quality control tests for SFRC to be used in precast segments, Molins et al. (2006).

TEST	CONFIGURATION	FAILURE SURFACE (cm ²)	ESPECIFIC FAILURE SURFACE
Beam ASTM C-1018		10x10 = 100	0,0286
Beam NBN B 15-238		15x15 = 225	0,0133
Beam EFNARC		7,5x12,5 = 93,8	0,0182
Beam RILEM		15x12,5 = 187,5	0,0152
Panel EFNARC		8x(32,5x10) = 2.597,7	0,0722
Round Determinate Panel		3x(40x7,5) = 900	0,0238
DPT		3x(7,5x15) = 337,5	0,1274

Shear capacity

Shear of steel fibre concrete is tested with beam tests or special irregular shaped specimens as in Figure 2.6. These are seldom considered to be used in pre-design test for inverse analysis or verification. For examples of standardised test for shear see e.g. (Khanlou, 2012).

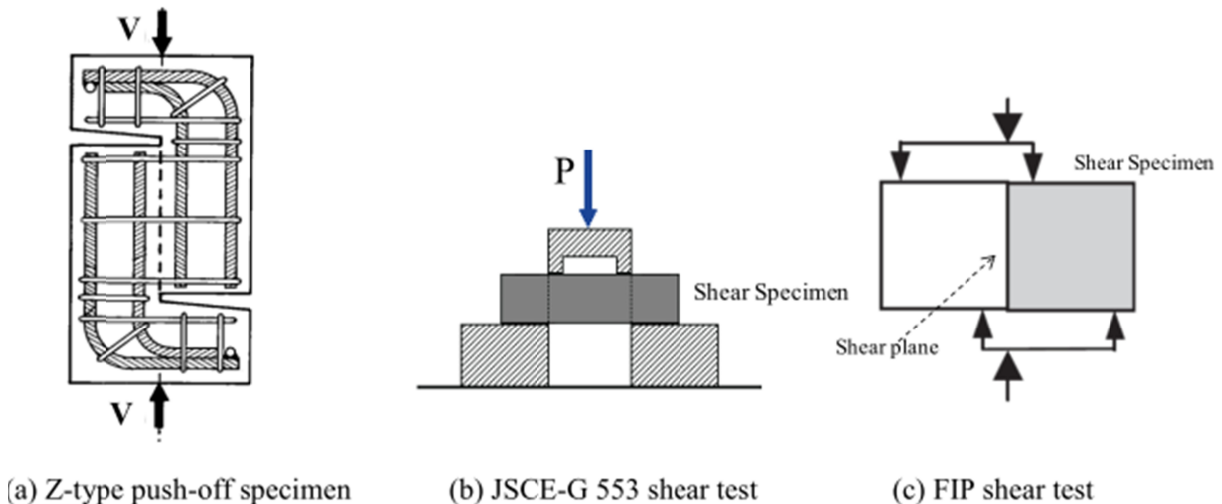

Figure 2.6: Example principles of standardised test for shear given by Khanlou (2012).

Scatter of SFC performances in bending

Work in this area is of constant interest of many researchers and there are numerous suggestions to take care of the fibre distribution through fibre counting and derivation of distribution factors etc. to find a more depicting material property. The variations of toughness performances of FRC are a well-known limitation for its use in structural applications.

“This shortcoming is not only caused by the heterogeneity of the material itself. It is also emphasized by the test method used to determine the FRC properties.” (Parmentier, et al., 2008).

The test method by itself results in difference in set-up that influences scatter. The most important factors, according to the Brite-Euram Project (BPR-CT 98-0813 - *Test and Design Methods for Steel Fibre Reinforced Concrete*), (Stang et al., 2001) are fibre dosage, geometry of the tested specimens (depth), test method, parameter observed, aggregate and fibre size.

Furthermore the author has noticed that the scatter could be significantly reduced in real testing, when using the test SCA (1997) method for un-notched prismatic beam in bending. In at least one project (380 million SEK in size for fibre concrete and concrete structures) the scatter was reduced to below 10 % by changing material sampling, filling the moulds with wheel-barrow and by using a vibrator table instead of sampling and filling the mould with

2.4. TEST METHODS AND STANDARD TEST METHODS FOR SFC

scoop (bailer), and hammer on the side. Also education of the sampling personnel was momentous. This sampling was made for over 200 test beams with different fibres and concretes.

It is well known that the scatter of toughness in beam bending test is in the neighbourhood of 10-30 %, therefore this is also accounted for in design, often with material factors of similar magnitude used for ordinary plain concrete. This does not imply that other test methods with less scatter are more useful in characterisation of the material properties. First of all the material and the material tests must commute with the mechanical the laws that are used in design.

However according to Bernard by comparing a round panel and a square panel test method he found that there was only a scatter of 6 % to 9 % which seems to be in advantage compared to bending test on prismatic beams (Bernard, 2002). What can be said about these tests is that the round statically in-determinate slab has no simple or exact solution.

The support condition of the round slab may introduce both membrane and arch effects into the circular SFC specimen. If the horizontal displacement is not completely free there will be such effects. If an arch is developed inside the specimen the failure will partly be dependent on the compressive strength of the SFC. We know that the scatter in compressive strength is rather small which means that it is likely that the scatter diminishes with increasing arch effect.

The the round in-determinate slab has different boundary and material condition in every single test and is also resulting in varying number of cracks and should therefore result a in large coefficient of variance (COV), but is not, relative to other test methods. If accounting to that and reveal all visible cracks the coefficient of variance (COV) is significantly reduced, however the material properties differ from what is found in classical beam bending tests. An explanation to that can be that the cracks find their own ways, and therefore, it is not possible to determine the total crack length, or even possible to verify that the total mechanical force is utilised in the opening of the visible cracks without fading out in the structure. The mechanical force applied is, except developing visible macro-cracks, also introducing micro-cracks and micro shear cracks as the force is shaping indefinitely many compressive trusses around its support. These structural energy absorption is therefore accounted faulty as material property. Knowing that an increased fibre addition contribute to a stiffer slab or beam in bending, a fibre concrete with larger fibre addition will produce larger scatter than the one with moderate fibre addition. Another fact is that the more crack the smaller the crack opening (and rotation crack surface around the crack) becomes, and the fibres are therefore working in different sizes of crack mouth opening displacements (CMOD). This make it even less possible to decide how many of the fibres that really contribute to the load transfer in the cracks, the fibre is in part in tension while others are sliding and have lost their bond throughout the many crack surfaces. Therefore a material relationship is impossible to build. Also using the stress redistribution for one structure does not mean that another structure can utilise the same amount of stress redistribution and is therefore insecure.

The Concrete Society report TR 63 (2007) has also explained why the round plate bending test is not applicable in material tests for characterisation of material that shall be input for design.

Therefore a statically determinate test method that is as the 3PBT and the 4PBT for beams or square slabs is preferred to be used.

Scatter of SFC performances in shear

In a recent master thesis at KTH, (Mondo, 2011), has shown that there is a wide spread in the test results behind the evaluation of all of the current proposed design methods, see Table 2.2, and that the use of them differs. She suggests using the Italian proposal in CNR (2006) among the investigated candidates Narayanan & Darwish (1987), DafStB (2010) and Rilem (2003).

Table 2.2: Average values of standard deviations of V_{exp}/V_{tot} for four alternative proposals on how to calculate shear resistance. V_{exp} = Experimental shear strength, V_{tot} = Computed total shear strength. Reproduced from Mondo (2011).

	<i>N&D</i>	<i>DafStB</i>	<i>RILEM</i>	<i>CNR</i>
<i>Average value of V_{exp}/V_{tot}</i>	1.58	1.95	1.40	1.49
<i>Standard deviation of V_{exp}/V_{tot}</i>	0.60	0.59	0.42	0.45

Swedish standards on SFC material

The existing Swedish standards for steel fibre concrete as a material are national adoptions of the European standards. As can be seen the EN 14650 and EN 14651 for precast concrete, is anyway used for ordinary SFC applications as slabs etc. that normally have lower requirements in design codes and building regulations. The standards also refer to EN 206-1:200 – Part 1: Specification, performance, production and conformity.

Swedish standards:

- SS-EN 14650 (2005), *Precast concrete products – General rules for factory production control of metallic fibre concrete*. However the conformity control is not specified in this standard.
- SS-EN 14651 (2005), *Test method for metallic fibre concrete - method of measuring the flexural tensile strength (limit of proportionality (LOP), residual)*. The standard provides a test method for metallic fibered concrete on moulded test specimen. The test is a 3PBT with a notched beam. Fibres should not be longer than 60 mm and the method can also be used if a combination of fibres and, a combination of fibres with other fibres is used. Comment: Here they probably mean combination of Steel and Steel with different properties like the aspect ratio etc., and a combination of fibres in different materials, which is not all clear from the text in the standard.
- SS-EN 14721 (2005), *Test method for metallic fibre concrete – Measuring the fibre content in fresh and hardened concrete*. The standard specifies two

2.4. TEST METHODS AND STANDARD TEST METHODS FOR SFC

methods of measuring the fibre content of metallic fibre concrete. Method A measures the fibre content of a hardened concrete specimen. Method B measures the fibre content of a fresh concrete specimen.

- SS-EN 14845-1, (2007), *Test methods for fibres for concrete – Part 1: Reference concretes*. Scope: This European Standard specifies the composition and characteristics of reference concretes used to evaluate the performance of fibres in concrete.
- SS-EN 14845-2, (2006), *Test methods for fibres for concrete -Part 2: Effect on concrete*. Scope: The standard specifies a method for determining the effect of fibres, steel or polymer, on the residual flexural strength of a reference concrete.
- SS-EN 14889-1, (2006), *Fibres for concrete – Part 1: Steel fibres – Definitions, specifications and conformity*. Scope: This Part 1 of EN 14889 specifies requirements for steel fibres for structural or non-structural use in concrete mortar and grout.
- SS-EN 14889-2, (2006), *Fibres for concrete – Part 2: Polymer fibres – Definitions, specifications and conformity*. Scope: This Part 1 of EN 14889 specifies requirements for polymer fibres for structural or non-structural use in concrete mortar and grout.

As can be seen the existing standards cover only the material SFC and do not yet consider the most critical part; the design and applications of SFC. There is however an on-going work in SIS TK 556/AG1 *FRC Design*, and it is expected to be drafted in end of year 2012 and become a standard in the end of 2013. The working name on the standard is SS 81 23 10 *Design of fibre concrete structures*.

Test methods and standards used internationally

The listed standards are used internationally in verification of SFC:

ASTM International formerly known as American Society for Testing and Materials (ASTM).

- ASTM A820 / A820M (2011) *Standard Specification for Steel Fibers for Fiber-Reinforced Concrete*. This specification covers minimum requirements for steel fibres. This specification provides for measurement of dimensions, tolerances from specified dimensions, and required minimum physical properties, and prescribes testing procedures to establish conformance to these requirements.
- ASTM C1116 / C1116M (2010) *Standard Specification for Fiber-Reinforced Concrete*. This specification covers all forms of fibre reinforced concrete that are delivered to a purchaser with the ingredients uniformly mixed, and that can be sampled and tested at the point of delivery. (American and international standards)

- ASTM Standard C1018-97 (1997), *Standard Test Method for Flexural Toughness and First-Crack Strength of Fiber-Reinforced Concrete*. The test method based on third-point loading (i.e. 4PBT with point loadings at each third of the span length) evaluates the flexural performance of toughness parameters derived from fibre-reinforced concrete in terms of areas under the load-deflection curve obtained by testing a simply supported prismatic beam. This test method was withdrawn in May 2006 due to lack of interest and support for its continued use. (American and international standards)
- ASTM Standard C1550-10 (2010), *Standard Test Method for Flexural Toughness of Fiber Reinforced Concrete (Using Centrally Loaded Round Panel)*. The standard concerns a test method that covers the determination of flexural toughness of fibre reinforced concrete expressed as energy absorption in the post-crack range using a round panel supported on three symmetrically arranged pivots and subjected to a central point load. The performance of specimens tested by this method is quantified in terms of the energy absorbed between the onset of loading and selected values of central deflection. The test method provides for the scaling of results whenever specimens do not comply with the target thickness and diameter, as long as dimensions do not fall outside of given limits. (American and international standards)
- ASTM Standard C1609 / C1609M-10 (2010), *Standard Test Method for Flexural Performance of Fiber-Reinforced Concrete (Using Beam With Third-Point Loading)*. According to the scope of the standard: *This test method evaluates the flexural performance of fiber-reinforced concrete using parameters derived from the load-deflection curve obtained by testing a simply supported beam under third-point loading using a closed-loop, servo-controlled testing system.* (American and international standards)
- JSCE-SF4, *Standard for Flexural Strength and Flexural Toughness, Method of Tests for Steel Fiber Reinforced Concrete*. The JSCE-SF4 method provides an absolute value of the flexural toughness, T_{JSCE} . The toughness factor, f_{JSCE} , can be considered as an average flexural strength for deflections up to $L/150$. “As compared to the ASTM method, there is no need to determine the point of first crack and the evaluated values are not as sensitive to instabilities in test results. Also, this method is reported to better differentiate between different SFRC of various fibre types and concrete mixes than the ASTM C1018,” Morgan, Mindess and Chen (1995) “Disadvantages includes an absolute value of toughness which is completely size dependent as compared to the relative toughness values and the designated deflection of $1/150$ of the span width is very large compared to normal applications. The method does not distinguish between pre- and post-peak behaviour and therefore different mixtures with separate behaviour may theoretically have the same toughness values,” (Groth, 1996). (Japan)

2.4. TEST METHODS AND STANDARD TEST METHODS FOR SFC

- NBN B 15-238 (1992) *Essais des bétons renforcés de fibres – Essai de flexion sur éprouvettes prismatiques* (Testing of fibre reinforced concrete - Bending test on prismatic specimens) NBN Bureau de normalisation. (Belgium)
- NBN B 15-239 (1992). *Caractérisation d'une fibre d'acier au départ de la résistance conventionnelle à la flexion* (Characterization of fibre strength from conventional resistance to bending) NBN Bureau de normalisation. (Belgium)
- N FP 18-409 (1993), *Béton avec fibres métalliques - Essai de Flexion*. (Steel fibre concrete – Bending test) Normalisation française, AFNOR. (France)
- UNI 11037 (2003), *Steel Fibre to be used in the Preparation of Reinforced Concrete Conglomerate*. The object of the document is fiber-reinforced concrete structures. The guideline refers to CEN EN 1992-1-1, 2004, CEN EN 14721 (2005), CEN EN 14651 (2005). (Italy)
- UNI 11039-1 (2003) *Steel fibre reinforced concrete - Definitions, classification and designation*. (Italy)
- UNI 11039-2 (2003) *Steel fibre reinforced concrete - Test method for determination of first crack strength and ductility indexes*. (Italy)
- RILEM TC 162-TDF (2001). *Test and design methods for steel fibre reinforced concrete - Recommendations for uni-axial tension test*. Materials and Structures. (International)
- RILEM TC 162-TDF (2002) *Recommendations of RILEM TC 162-TDF: Test and design methods for steel fibre reinforced concrete: bending test*. (International)
- RILEM TC 162-TDF (2003) *Final recommendation of RILEM TC 162-TDF: Test and design methods for steel fibre reinforced concrete sigma-epsilon-design method*. (International)

Chapter 3

Pile supported slabs - the design matters

3.1. Standards and guidelines used in design and construction

Swedish guidelines

The design of concrete structures and also other types of structures was in historical time (but not so far ago) often carried out by company own values and design methods, seldom shared with others. To harmonise and make design safer with respect to collapse and other failures building regulations and design code rules are needed. The design codes often refer to trade and interest associations as the *Swedish Concrete Association (SCA)* and *preliminary* or *existing standards* developed at the *Swedish Standard Institute* in co-operations between the interested companies; that finance and stand for the expertise in the working groups. This has made the guidelines to become respected. On the subject SFC, work has been on-going since the beginning of the 1970s as it was introduced commercially. Among the pioneers on fibre concrete in Sweden there are e.g. Skarendahl (1975), Skarendahl & Westerberg (1989), Holmgren (1987, 1992, and 1993). Holmgren focused on shotcrete applications. The first Swedish guidelines on steel fibre reinforced concrete floors were Skarendahl & Westerberg (1989), Westin et al. (1992) and Westin et al. (1994).

The main Swedish guidelines and sources dealing with floor construction and SFC are presented below:

CBI report No. 1:89 by Skarendahl & Westerberg (1989).

The Concrete Manual, Execution (Betonghandbok Arbetsutförande), (edition 2, 1997) and *The Concrete Manual, Material* (Betonghandbok Material), (edition 2, 1997), give only short references to fibres in concrete for floors as a reinforcement material. *The Concrete Manual, Design* (Betonghandbok - Konstruktion), (utgåva 2, 1997) has no references to fibre concrete but presents design calculations for flat slabs that is frequently referred to for pile supported slabs on ground.

The *Swedish Concrete Society Concrete report on Steel Fibre Concrete* (SCA, 1997) has been used for design of various kinds of SFC products including floors, precast elements as

balcony slabs and walls and facade elements and foundations for housing and agriculture purposes. Structures as ground supported slabs (non-structural) and pile supported floors are common and other bearing structures e.g. flat slabs and foundation slabs, are frequently designed. Even if the latter is out of the scope of this report; in-situ cast load bearing structures have been given load combinations and partial safety factors γ_f in Table 2.2 and partial coefficient product $\eta\gamma_m$ and crack safety coefficient ζ , in Table 2.3 of report no. 4 (SCA, 1997), i.e. to be used when design with steel fibre concrete.

The SCA committee primarily directed the work towards slabs, mainly on ground, but in the design tables and in the text there are examples, design equations and material properties for other structures, that also is load bearing. This is maybe somewhat confusing but the committee reached consensus and may have had an idée from experience that the SFC had more potential than they dared to fully stand for in that time. On the other hand the report no. 4 gives examples on important subjects for future research, both for the material SFC and for SFC structures. The proposals for future research from the writers included a longer text on proposed development areas (see also chapter 5.2 in this thesis). The examples are e.g. fatigue, durability (corrosion resistance), and production issues i.e. mixing of moderate to high content of fibres to the concrete and rheology, crack distribution for restrained shrinkage and temperature movements, restraint stresses and crack risk and crack patterns, behaviour at combined external and restraining loading, limit analysis on SFC structures and rotation capacity, moment and shear capacity and behaviour of combined reinforced structures i.e. combinations of micro fibres, macro fibres, bar reinforcement and steel fibres, and pre-tension and steel fibres. Behaviour and bearing capacity of elevated flat slabs that is locally steel fibre reinforced, and strengthening of concrete structures through toppings, overlays or sprayed concrete. Obviously the writers and the experts behind the report could see a future where SFC would be used in structures and elevated flats slabs rather than keeping the material only on the absolute ground and for use in simpler structures.

More than ten years later the *Swedish Concrete Association's*, Concrete report No. 13, Industrial Floors, (SCA, 2008) again treats SFC. It have like the previous, report no 4, since it have been referred to by many design engineers in Sweden. Report No. 13 is also used by clients/ end-users, contractors and designers for industrial ground supported slabs and pile supported floors, but also for other types of concrete slabs both of ordinary concrete and SFC because of its more or less complete recommendations. A main advantage has been its resolute recommendation on how to consider cracking and especially crack widths and also it gives design examples on that. A new approach in the report No. 13 was the introduction of *crack width classes (I - IV)*, this has been frequently used since then and it will be exciting to see if it has influenced the statistic for occurring damages. Also the report treats the industrial pile supported floor slab which is an important development.

The proposals for R&D in report No. 13 are connected to the chapters and the report gives 5 proposals on requirements and purchasing, and 11 proposals for material research and 2 on execution and 5 on floor slabs on ground and 12 on overlays. Explicitly the report proposes research regarding the behaviour of SFC pile supported floor slabs. It states that the method of yield line analysis often is used and therefore the rotation capacity must be proven to be large enough. The reports state that the ground for this for SFC and the combination of traditional steel and SFC (i.e. reinforced SFC) must be examined. The report gives recommendations for

3.1. STANDARDS AND GUIDELINES USED IN DESIGN AND CONSTRUCTION

limits on residual strength factors for pile supported floors designed with these solutions in the proposed crack width classes.

In a coming report type examples on industrial concrete floors (also pile supported) are treated by Silfwerbrand & Hedebratt (2013).

The Swedish standard organisation SIS, working group TC556/ AG1 (former TC203/AG2) is at time being involved in standardisation on SFC design of structural SFC. The work aims to generate an amendment standard confining to Eurocode 2.

Standards and national guidelines internationally

The main international and national guidelines out-side Sweden for testing and design of SFC are the following ones (not classified after usage or year of publication):

- ACI 318-08, (2008). *Building Code Requirements for Structural Concrete*, American Concrete Institute. This code does not treat SFC explicitly but contains definition of structural SFRC for shear reinforcement. (American Concrete Institute Code)
- ACI Committee 544, (1996), *Report on Fiber Reinforced Concrete* (ACI 544.1R-96) (Reapproved 2009). The report reviews all types of FRC. It treats e.g. fundamental principles of FRC, manufacturing methods, mix proportioning and mixing methods, installation practices, physical properties, durability, design considerations, applications, and research needs. (Recommendations of American Concrete Institute)
- ACI 360R-10 (2010), *Guide to Design of Slabs-on-Ground*. This guide presents information on the design of slabs-on-ground, primarily industrial floors. It addresses the planning, design, and detailing of slabs. Design theories are followed by discussion of the types of slabs, soil-support systems, loadings, and jointing. Design methods are given for unreinforced concrete, reinforced concrete, shrinkage-compensating concrete, post-tensioned concrete, fibre-reinforced concrete slabs-on-ground, structural slabs-on-ground and slabs-on-ground in refrigerated buildings, followed by information on shrinkage and curling. Advantages and disadvantages of these slab design methods are provided, including minimizing cracking and curling. (Recommendations of American Concrete Institute)
- ARMY TM 5-809--12 (1987), *Concrete Floor Slabs on Grade Subjected to Heavy Loads*. This manual prescribes the criteria for the design of concrete floor slabs on grade in buildings for heavy loads and is applicable to all elements responsible for military construction. Heavy loads in buildings such as warehouses include moving loads, stationary live loads, and wall loads. Chapter 5-15 - 5-18 is designated to steel fibre reinforced concrete (USA)
- CUR 36 (2011), *Ontwerpen van elastisch ondersteunde betonvloeren en – verhardingen* (*Design of concrete floors and pavements on elastic found-*

ations). This Recommendation contains rules for the determination of bearing capacity and for the assessment of the usability limit states (deformations, crack formation, flatness) of elastically supported industrial floors in concrete. Furthermore, it includes recommendations with regard to the loads to take into account. (The Netherlands)

- CUR 111 (2007) *Steel fibre reinforced concrete industrial floors on pile foundations - Design and construction*. Scope: This Recommendation refers to industrial floors of structural concrete with a combination of steel fibres and reinforcing steel. The floors are founded on piles and cast on subsoil that may not to be removed after construction. Examples are industrial floors and floors of warehouses. The steel fibre reinforced concrete should meet the following requirements: the minimum steel fibre content is 35 kg/m³ (app. 0.45% (m³ /m³)) at a weight by volume of 7850 kg/m³); the direct length of the steel fibres is maximum 60 mm; the composition of the fresh concrete is in accordance with NEN-EN 206-1 and NEN 8005. (The Netherlands)

DAfStb (2010). DAFStb guidelines: DAFStb - *Richtlinie Stahlfaserbeton (Recommendations for Steel Fibre Concrete)*. Amendment to DIN 1045 (Germany) (In German)

- DBV-Merkblatt Faserbeton (2001), *Guide to Good Practice - Steel Fibre Concrete*. The principally headings in table of content are materials, design values, specification, safety concept, methods for structural analysis, design, general detailing rules, rules for execution, quality control, test to determine the tensile strength. (Germany)
- DIN 1048 (1991), *Testing concrete, part 1, Testing of fresh concrete: post-crack load capacity of fibre reinforced concrete*, DIN, Berlin, 1991. (Germany)
- Model Code 2010, *fib Final draft of the basis for future codes*, (fib, 2011). The model code is the basis for future developments of codes and standards in Europe. In the latest model code MC 2010 SFR concrete is treated in chapters including both material (chapter 5.6) and design (chapter 7.7) for structural purposes. (International)
- TR34 (2003) *Concrete industrial ground floors - a guide to their design and construction. 3rd edition*, a Concrete Society technical report The report treats floor design and construction of industrial floors, as the title proposes. There are four main parts, operating requirements, design aspects, concrete performance and design aspects, best practise in construction and maintenance. (Great Britain)
- TR 63 (2007), *Guidance for the Design of Steel-Fibre-Reinforced Concrete. "The Concrete Society Technical Report 63 summarises the wide range of current applications for steel—fibre-reinforced concrete, including ground-supported and pile-supported slabs, sprayed concrete, composite*

3.1. STANDARDS AND GUIDELINES USED IN DESIGN AND CONSTRUCTION

slabs on steel decking and pre-cast units.” TR 63 (2007). The report advice on practical aspects including production and quality control. The Report reviews the methods currently used, with the aim of promoting an understanding of the technical issues involved. (Great Britain)

- CNR-DT 204/2006 (2007), *Guide for the Design and Construction of Fiber-Reinforced Concrete Structures*. Italian National Research Council. The guide is extensive and gives recommendations on design based on e.g. the work of Rilem TC 162-TDF. (Italy) (In English)
- UNI 11188, (2004). *Design, Production and Control of Steel Fiber Reinforced Structural Elements*. (Italy)
- UNI 11188, (2007) *Steel Fibres Reinforced Concrete Structural Elements - Design, Execution and Control*, This standard defines requirements for strength, serviceability and durability of steel fibres reinforced concrete structural elements, with or without additional reinforcement. (Italy)
- RILEM TC 162-TDF (2001). *Test and design methods for steel fibre reinforced concrete - Recommendations for uni-axial tension test*. Materials and Structures (International)
- RILEM TC 162-TDF (2002) *Recommendations of RILEM TC 162-TDF: Test and design methods for steel fibre reinforced concrete: bending test* (International)
- RILEM TC 162-TDF (2003) *Final recommendation of RILEM TC 162-TDF: Test and design methods for steel fibre reinforced concrete sigma-epsilon-design method* (International)
- SIA 162/6 (1999), *Empfehlung Stahlfaserbeton (Recommendation on Steel Fibre-Reinforced Concrete)*. This recommendation is primarily based on experiences on steel fibre shotcrete. (Switzerland)

CUR 111 allows for the use of SFC in combination with steel reinforcement to contribute in the total shear stress resistance but does not allow for using fibres in the punching shear resistance.

The Concrete Society report TR 63 outlines that round indeterminate plate tests are not covered by standards and are not a method to determine the fundamental properties of SFRC. The proposal from the Concrete Society is to use the RILEM TC-162 TDF methods. The uniaxial test for determining the basic stress-crack width (σ - w) relationship to be used for advanced design procedures while the beam test is ideal for development work on fibres and for assessing the influence of fibre type in the laboratory. (TR 63, 2007)

In Germany a work is finalised by DAfStb – *Richtlinie Stahlfaserbeton* (2010), a guideline that confines to DIN 1045, and is expected to be accepted as a valid design code.

As can be seen by the title, Rilem (TC162-TDF) has worked out design methods for SFC structures. These may form the base of the Eurocode for Steel Fibre Concrete and is also base for the MC 2010 and the standard test method for flexural bending in EN 14651. The international organisation fib - Fédération internationale du béton, is working on the new fib model code that includes SFC as a design material. fib commission T 8.3 *Fibre reinforced concrete* is convened by Lucie Vanderwalle, Katholieke Universiteit Leuven. The draft model code, MC 2010 has two chapters concerning FRC (see above).

In Norway Kanstad, T. (NTNU), et al. (2011) have made proposals for guidelines for design, execution and control of fibre reinforced concrete structures, in the COIN/ SINTEF report *Forslag til retningslinjer for dimensjonering, utførelse og kontroll av fiberarmerte betongkonstruksjoner (Proposals for guidelines on design, execution and control of fibre reinforced concrete structures)*. This recommendation has taken as a starting-point from the report by Thorenfeldt et al. (2006). The report is also based on recent guidelines from DAFStb, The Concrete Society, ACI and fib Model Code 2010 and refer to NS-EN 1992-1-1.

Except these above recommendations for design and construction there are a large number of company specific guidelines and private guidelines in the field of SFC also including pile supported slabs. The mutual basis for most of the newer guidelines is the amendment to Eurocode 2 and the EN 14651 test method, even if there are some differences in the opinions of the expert groups and national adoptions. A common standpoint seems to be how the concrete cracks and that a hardening behaviour is beneficial for structural purposes.

3.2. Design of pile supported slabs and flat slabs

Historical and theoretical review

Pile supported slabs are traditionally designed in the same manner as elevated flat slabs with respect to same theories even if the safety levels sometimes are kept lower at ground level. The theories behind elastic design were derived by *Harald Malcolm Westergaard* (1888-1950), with important contributions to theory of elasticity and plasticity e.g. Westergaard (1921, 1922, 1923, 1925, 1926 and 1952), and much later *Arne Hillerborg* (1923-2011), with inventions as the *strip method* and the *fictitious crack model*, see e.g. (1974, 1975 and 1976).

In Denmark *Knud Winstrup Johansen* (1901-1978) contributed to the *yield line theory* (YLT), see e.g. Johansen (1931, 1943, 1962 and 1972) in the 1930s. The YLT was refined from earlier work by *Aage Ingerslev* (1889-1928) e.g. Ingerslev (1921, 1923) by Johansen, and later to ground slabs by *Anders Losberg* (1918-1981), see e.g. Losberg (1960), in the 1960s. And to elevated flats slabs by *Sven Kinnunen* (1930-2009) och *Henrik Nylander* (1914-1993), see e.g. Kinnunen & Nylander (1960).

At KTH the phenomenon *punching* has a long story. In the fifties Professor *Henrik Nylander* and his young *assistant Sven Kinnunen* (later Professor) performed tests on circular slabs on columns and developed a theoretical model. Several PhD students produced reports e.g. Andersson (1963, 1964), Birke (1975), Tolf (1992), Hallgren (1994, 1996), Hassanzadeh (1998) and Nilsson (2003).



Figure 3.1: Punching shear cracks in a circular RC plate punching test, from (Hallgren, 1998)

According to Holmgren, who has summarized the punching research history at KTH, also: *The reports cover areas as shear reinforcement, lift slabs, edge columns, corner columns, post tensioned reinforcement, dynamic loading, influence of the slab thickness, column footings, fracture mechanics and strengthening* (Holmgren, 2000).

In the year 2000 an international workshop on punching was held, it was dedicated to *Sven Kinnunen* (Silfwerbrand & Hassanzadeh, 2000).

In the year 2001 the international NCR Workshop on *The Design of Steel Fibre Reinforced Concrete Structures* was held in Stockholm. Several papers were presented from KTH e.g. a paper regarding *“The Influence of Steel Fibre Reinforcement on Punching Shear Capacity of Column Supported Flat Slabs”* (Sundquist & Hassanzadeh, 2001).

These theories and analysis methods are commonly used to calculate moments and moment capacities or shear and shear capacities for traditionally reinforced slabs as well as later on for SFC, on ground slabs on piles or columns or supported by walls.

No one of these predecessors (before the 1970s) studied or were familiar with the composite material steel fibre concrete as present known. The first approaches to design with steel fibre concrete were therefore conservative. When designing with SFC earlier, i.e. in the 1970s to 1990s, the designs were with elastic theories consequently with larger safety marginal. Gradually and more frequently SFC is designed with respect to theory of plasticity and especially the yield line theory.

Later approaches are merely directed towards finite element modelling of structures and the practical application of finite element analysis (FEA). With a preceding inverse analysis of the SFC material properties and or in combination with steel reinforcement (fabric mesh or bars), it is often possible to build finite element models (FEM) and perform analyses (FEA) and design structures with SFC, see e.g. Kullaa (1997), Kooiman et al. (2000), Hedebratt (2000), Meda & Plizzari (2004), Löfgren (2005), Døssland (2008) etc.

Requirements for design with structural SFC

The stresses from forces, moments and shear are usually larger in parts of a structure at local level, which is reinforced to redistribute the stresses. Other parts may have less need for reinforcement as long as the section's rotational capacity is large enough, i.e. the resistance in a plastic hinge or a plasticised zone is constant during ascending deformation so that the required rotation of the hinge could take place without exceeding the rotational capacity.

According to e.g. Eurocode 2 (1992) the use of non-linear analysis is allowed in designs both in ULS and SLS of reinforced concrete (RC) structures, in linear analysis with or without redistribution or the theory of plasticity (Schumacher, et al., 2009). In any situation the rotational deformation capacity must not exceed the demands in order to use these models.

In the Swedish code BBK 04 (2004) the rotational capacity ω for RC slab structures are considered to be enough if:

$$\omega = \frac{A_d}{d} \cdot \frac{f_{st}}{f_{cc}} \leq 0.1 \quad (3.1)$$

The rotational capacity for a reinforced concrete (RC) section in Equation 3.1 is calculated according to Swedish Concrete Manual (1997), Part: Construction, section 3.2:233.

An a global or local structural level strain softening SFC may be used in structural sense if the rotational capacity is sufficient. Approaches to model the rotational capacity for SFC have been investigated by e.g. Schumacher et al. (2009). Schumacher has modelled the rotation capacity of plastic hinges for SCSFRC similar to the models of Bigaj (1999) and Langer (1987) and Li (1997) for RC, (referred by Schumacher et al.). The calculation is performed in seven steps and was validated for SCC and SCSFRC members in bending. Schumacher et al.'s test were conducted with four beam (height $h = 300$ mm and width $b = 150$ mm, total beam length $l_0 = 3000$ mm and span $l = 2850$ mm.). The beams were reinforced with two ribbed bars and additionally the test parameters were no fibres or 60 kg/m^3 with fibre length $l_f = 30$ mm and aspect ratio $l_f/d_f = 80$ and axial compressive force $N = 0$ or $N = -400$ kN. The onset of steel yielding and the maximum load and the ultimate load were considered.

The rotation capacity observed in experiments was underestimated by the model. In the conclusions they point out that; for the investigated parameter the effect on steel fibres was significantly decreasing the overall rotation capacity. And that the model for calculation rotation capacity was suitable to simulate the deformation behaviour of SCSFRC member with ordinary reinforcement. The measured rotation capacities ($\theta_{\max} - \theta_y$) and ($\theta_u - \theta_y$) were 18.5 mrad and 51 mrad, respectively, and the calculated values 9.4 and 41, respectively, for the SCFRC beams to compare with measured 68 mrad and 68 mrad, respectively, 55 and 55 mrad, respectively, (θ_{\max} = rotation at max moment, θ_y = rotation at yield moment and θ_u = rotation at ultimate moment), see (Schumacher et al., 2009). As can be seen in figure 3.3 the rotational capacity in this specimens is larger than 0.1 according to the demand in equation 3.1 above from BBK 04 (2004).

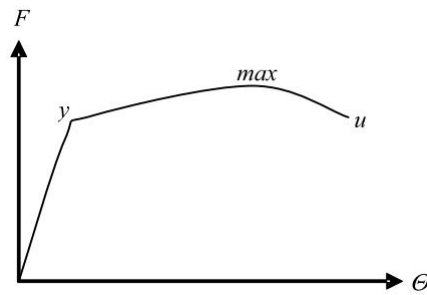

Figure 3.2: Definition of significant load steps, from (Schumacher et al., 2009).

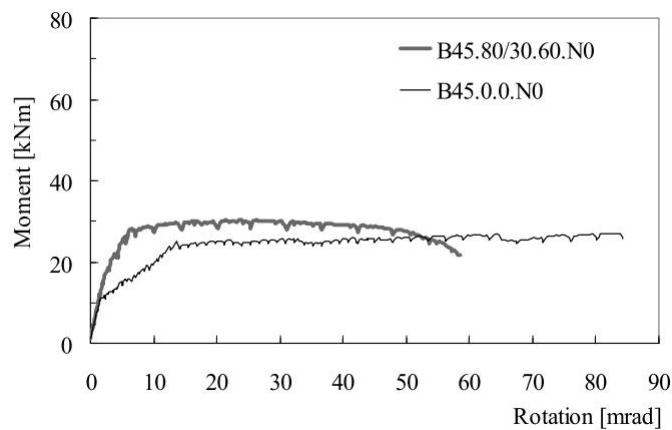

Figure 3.3: Applied moment in relation to rotation, without axial force, from (Schumacher et al., 2009).

Schumacher et al. conclude that the stiffness of the SFC that was tested was increased. It can also be concluded that the calculations were less predictable for the SFC, with 97 % underestimation. In case of RC without fibres the deviance from measured values was 23 % underestimation. However the number of tested beams was small so the conclusions could be erroneous and likely be improved with larger test series.

The conclusion that the stiffness increases with addition of fibres is also in agreement with the results from the short-term tests on the pile supported slab in **Paper C**.

Combined reinforcement or reinforced SFC

A combination of SFC and steel bar reinforcement is probably most economically where the reinforcement only is placed where the stresses are in excess of the strength properties obtained by SFC. It is implied by Figures 2.2 - 2.5 (in chapter 2.2) that SFC will behave structurally sound if the properties are strain or bending hardening, if the design or real stresses are above the limit of proportionality and in the area of flexural residual strength. No general reinforcement should be needed in that case. If using strain softening SFC a combined reinforcement is believed to be needed. In a global level the design check of the structure with

strain or bending hardening SFC should be easier; the issue is to find the maximum stresses and strains and match them with proper SFC. Therefore the SFC only design would be easier performed. In design of combined reinforced structures with strain softening SFC more extensive calculations are needed to get a reliable structure in every structural part.

The top layer of reinforcement bars in project No. 9 (from **Paper B**) was designed to carry the full magnitude of loading by itself. The SFC in-between carried the same load calculated for the full span. In this a particular part of the slab the loadings were 140 kN/m^2 .



Figure 3.4: The top layer of reinforcement bars in project No. 9 (from **Paper B**).

Response from ground-support in short- and long-term

When designing pile-supported floors slabs often the ground support is neglected, it has its due courses. Often the slab will have sufficient support to harden without too much bending induced from the dehydration settlement of the ground. If the ground is water saturated or even frozen problems with micro-cracking occurs immediately. If the draining is of magnitude, in long-term, there will become a space underneath the slab. This kind of settlements frequently occurs (the maximum space measured after long-term dehydration of ground is 1.4 m, measured in project No. 19, Strängnäs after only one year. Often the settlement is in the area of 10 – 50 mm.

The ground support acting beneath a concrete industrial floor slab varies substantially from floor type and between soil properties and the design states. In a soil with low ability to withstand pressure from above the piles must carry up to 100 % of the loads, and in a case where the compaction is large the piles can be designed with larger spacing. The slab is then

3.2. DESIGN OF PILE SUPPORTED SLABS AND FLAT SLABS

partly carried by a so called Winkler foundation. As can be seen by the hatched area in Figure 3.5a, which limits the SLS and the ULS, only a small part may be carried by the ground and that in ULS, whereas there is no ground support in the SLS.

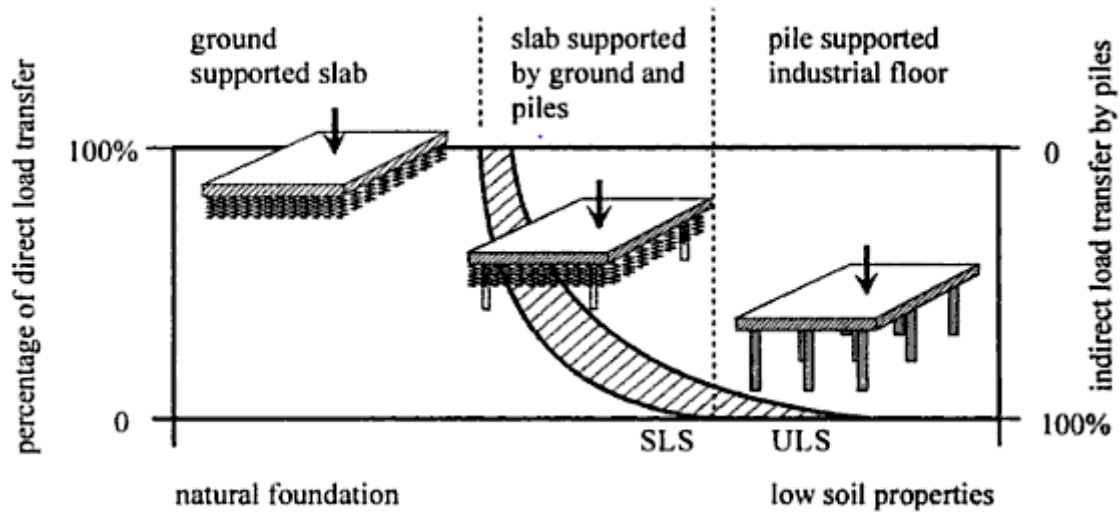

Figure 3.5a: The influence of soil properties on load transfer of industrial floors, Falkner (1999).

Obstacles in design with SFC

In structural elements (i.e. precast) the requirements on a defined load carrying capacity and limited deformations often are higher than in e.g. slabs on ground and pile supported floors due to safety and could therefore not be disregarded. Many of the standards on SFC as material and verification of SFC are based on standards for structural precast elements. However for many industrial concrete floor applications the limitations on deformations are a lot more explicit i.e. the demands may focus on small tolerances and even low vibrations or energy absorption.

A threshold has been and will be to bridge knowledge about SFC and to overcome the psychological effects of not using defined reinforcement segments using SFC (a steel bar is still a steel bar). The psychological resistance was also apparent when the modern reinforced concrete arrived and also with new concrete strengths. A parallel can be to China, in year 2005 the building codes allowed for only 200 MPa in characteristic tensile strength while we in Europe uses as standard 500 MPa (according to a speaker at the International Symposium on Innovation & Sustainability of Structures in Civil Engineering-Including Seismic Engineering (Volume 1), November 20-22, 2005, Nanjing, China), this was due control of large deformations which was a psychological resistance with not knowing or daring to design better. However, probably this extra toughness has saved a few houses in seismic active areas. Then research and testing was on how to use higher steel strength in concrete as they have heard the Europeans do.

Lack of local Swedish experience is the main issue often highlighted in design meetings with the contractors about design issues. Even if the world wide knowledge and experience have grown a lot since the invention of SFC (in 1874) there are still doubts about validity of design methods and control systems which in light of all research may seem odd. Now the knowledge on SFC is more wide spread than ever, and SFC is a popular field of research. Also the utilization of SFC in various applications has shaped experienced and interested contractors. Therefore this mark is obsolete.

3.3. Failure mechanisms and serviceability conditions

Design for moments

Moments are normally calculated from uniformly distributed loads (UDL) in ultimate limit state. Using the yield line theory moments reflecting the cracked SFC structure may be used in cases where the rotational capacity is sufficient and where the reinforcement is equally distributed in the structure. For a pile supported slabs with strip reinforcement the slab must be subdivided to calculate the strips and the slab parts separately.

Also moments occurs at bending and the bending is often larges at point or line loaded sections i.e. for a pile-supported floor slab where only UDL load exist the maximum moments occurs at supports.

The moment of resistance of SFC in elastic state is given by the beam theory and is calculated as:

$$M_R = \frac{f_{fd} \cdot h^2}{6} \quad (3.2)$$

where f_{fd} is design value of concrete flexural bending strength and h is the plate thickness. If M_R is exceeded then of course there is a margin and the slab will crack only eventually fail and crack. Often such a control is performed in the SLS.

The cracking of slabs on ground is often controlled for shrinkage induced restraint forces from friction but seldom from e.g. piles, and walls etc. in combination with other service loads from shrinkage and temperature movements. This kind of restraining forces is maybe of larger significance for pile-supported floors because the possible absence of ground support may occur earlier than expected. At least above the piles and around curled edges you will find cracks, in most floors (see **Paper B**). At the location of piles the utilized loadings will give tensional stresses, and bending moments from the piles give bending stresses, in the top of the slab and compress the slab in the bottom. Together with shrinkage and temperature induced stresses this widen the cracks. This will also occur at the curled edges but here also different kind of loadings (point-loads, line-load and UDL-loads) and restraints will further add moments and tensile forces.

The moment and force equilibrium must therefore be established at all possible locations where failure is expected to occur, this requirement follows also by the design methods used

3.3. FAILURE MECHANISMS AND SERVICEABILITY CONDITIONS

i.e. the yield line theory (YLT). One may also consider using other design methods where the YLT not is applicable. For steel fibre concrete also the residual strength is included in $f_{fl,d}$.

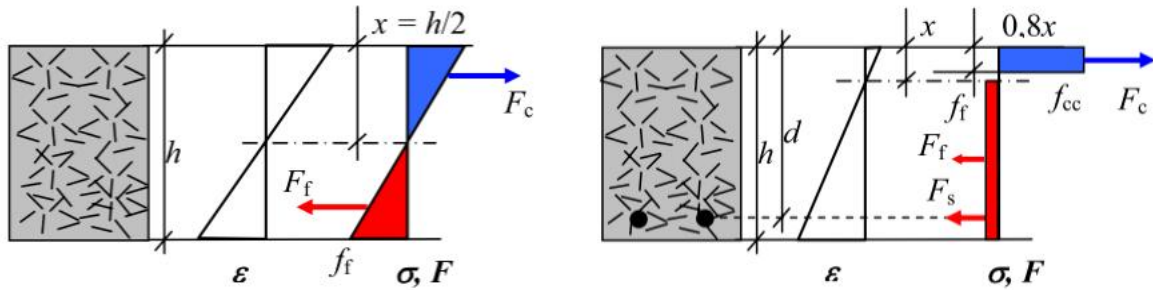

Figure 3.5b: Established moment equilibriums, to the left SFC and to the right SFC/RC, according to SCA report No.13 (2008).

The equations for moment capacity is derived from in the illustrative cross sections in Figure 3.5b and the residual strength factor is derived according to SCA report No. 4 (1997). Equation 3.3 is for steel fibre concrete and equation 3.4 is for a combination of steel fibre concrete and reinforcement bars.

$$\begin{aligned}
 M &= F_f \cdot \frac{2h}{3} \\
 F_f &= \frac{1}{4} \cdot f_f \cdot h \\
 f_f &= f_{flres} = f_{flcr} \cdot \frac{R_{10,30}}{100}
 \end{aligned}
 \tag{3.3}$$

$$\begin{aligned}
 M &= F_s \cdot \left(1 - 0,4 \cdot \frac{x}{d}\right) \cdot d + F_f \cdot \left(\frac{h-x}{2} + 0,6 \cdot x\right) \\
 F_f &= f_f \cdot (h-x) \\
 f_f &= f_{ct} = 0,37 \cdot f_{flres} = 0,37 \cdot f_{flcr} \cdot \frac{R_{10,30}}{100}
 \end{aligned}
 \tag{3.4}$$

Where

d = effective depth (m)

h = cross sectional dimension (m)

M = moment capacity (kNm/m)

x = height of compressive zone (m)

ε = strain distribution

σ = stress distribution

F = forces

f_{cc} = design compressive strength for concrete (MPa)

f_t = design tensile strength for fibre concrete (MPa)

f_{flcr} = design value of fibre concrete flexural tensile strength (MPa)

f_{flres} = design value of fibre concrete residual flexural tensile strength (MPa)

f_{ct} = design value of fibre concrete pure tensile strength (MPa)

F_c = resulting compressive forces in the concrete (kN)

F_f = resulting tensile forces in the fibre concrete (kN)

F_s = resulting tensile forces in the steel reinforcement (kN)

$R_{10,30}$ = residual strength factor (%)

Established design moments

From several textbooks one can find examples on how the YLT is established for pile-supported slabs. The principle failure moments are on the lower limit of design i.e. because the theory is based on identification of the lowest moment that the slab may carry. The failures often occur at piles as circular cracks or along with the pile lines and between the piles in parallel with the failing yield pile line. Therefore design moments are often determined by using the YLT. Two patterns are usually analysed, (A) circular YL above the pile heads and (B) straight YL above and between the pile rows. (Figure 3.6)

The Figure 3.6 is from Hedebratt & Silfwerbrand (2004) and Kinnunen & Nylander (1974) given in the SCA report No.13 (2008). The solution to the yield line patterns are:

$$\begin{aligned}
 m_{A,d} &= q_d \cdot \frac{l_{pd}^2}{4\pi} = \frac{P_u}{4\pi} \\
 m_{B,d} &= q_d \cdot \frac{l_{pd}^2}{16} = \frac{P_u}{16} \quad m_u = \frac{f_{fld} \cdot h^2}{6} \leq \min \begin{cases} m_{A,d} \\ m_{B,d} \end{cases}
 \end{aligned}
 \tag{3.5}$$

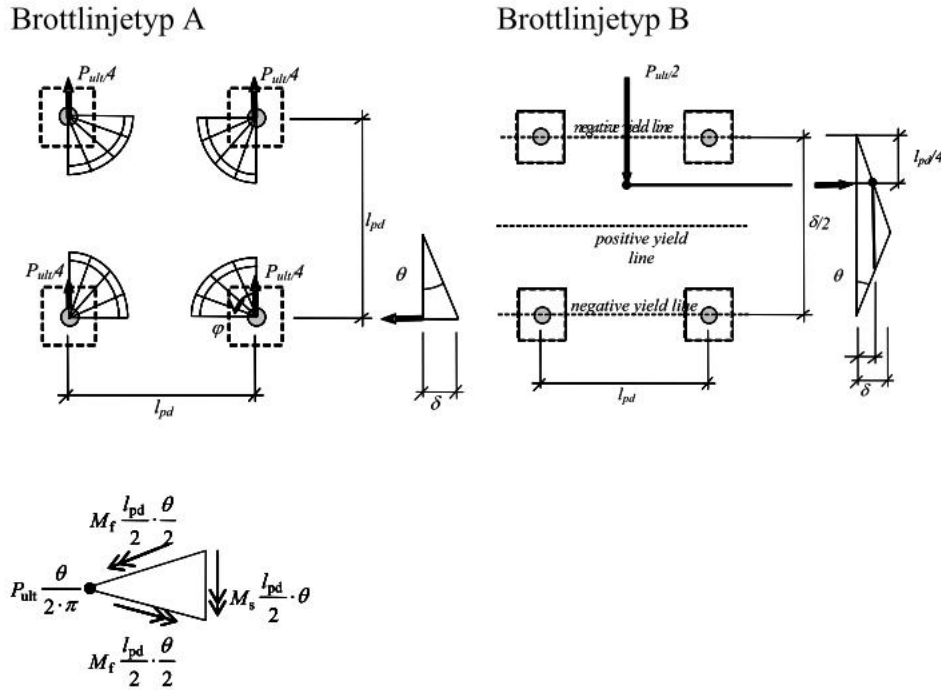

Figure 3.6: Design moments according to SCA No. 13 (2008) after Hedebratt & Silfwerbrand (2004) and Kinnunen & Nylander (1974).

Design for punching shear

For steel fibre concrete punching it is proposed to use the SCA report No. 13 model given in equation 3.7.

$$f_{v1} = \frac{\xi}{1.4} \cdot C \cdot \frac{f_{fl}}{\zeta} \quad (3.6)$$

where C = constant that may be $C = 0.45$, $f_{fl} = f_{flres} = f_{flcr} \cdot R_{10,30} / 100$ (see also Figure 3.5b and the crack safety factor $\zeta = 2 - R_{10,30} / 100$. In calculation of carrying capacity the effective height d is equal to plate thickness h . See also SCA report No.4 (1997).

For punching of steel fibre concrete in combination with steel reinforcement bars it is proposed to use the SCA report No. 13 model given in equation 3.8.

$$f_{v1} = \xi \cdot (1 + 50\rho) \cdot 0.45 \cdot f_{ct} + 0.41 \cdot \tau_f \cdot F_f \quad (3.7)$$

where τ_f = bond strength between concrete and fibres (normally $\tau_f = 4.15$ MPa), F_f = fibre factor. $F_f = (l_f / d_f) \cdot \mu_f \cdot \rho_f$, where l_f , d_f , μ_f and ρ_f is the fibre length, diameter bond factor and fibre content. See also SCA report No. 4 (1997).

For punching shear the author earlier has proposed a solution in Hedebratt (2003a), Hedebratt & Silfwerbrand (2004), Hedebratt & Silfwerbrand (2005). The proposed design was a modification of the formulas for shear in beams according to Narayanan & Darwish (1987) modified and given by SCA (1997) and in combination with the rules for punching of slabs in the Swedish design code BBK 04. Instead of using the width b of the beam and $A' = 0.30$ the author proposed to use the values in the similar formula in BBK 04 for punching, where $A' = 0.45$ $b =$ the critical perimeter $= u_1$, and with the addition of fibre contribution in SCA (1997). With this method the punching shear capacity increases with the size of the pile cap and punching can be calculated in different positions of the slab and with various geometry of the load. Also the contribution of fibres is $= 0$ if there is no fibres included.

In at least 50 building projects with pile supported floors this way of evaluating punching shear has been successful by the author. Some of the projects are discussed in **Paper B**. However, argument against this way of calculation can be raised; in fact there has not been any verification through testing. The verification has only been inspections of constructed floors, and thereby it is difficult to determine how big the marginal is until punching failure may occur.

In the full scale testing described in **Paper C** and **Paper D** you may indeed see that two punching failures may have occurred at high level loading.

Design for deformations

The **Paper D** propose a model for control of time dependent deformation based on the long-term testing of a column and wall supported slab simulating a pile supported slab. The model is based on the theory of elasticity for moments and deformations (in e.g. the Swedish Concrete manual (1997) and the model for creep in SS-EN 1992-1-1, se Appendix A.

By using the mean values of temperature and relative humidity of air the model for creep in Paper D has been used to calculate the cumulative creep deformation on loaded slab panels.

Design for crack control

A well-known dilemma: The crack reinforcement of slab-on-grade is a well-known dilemma. To describe the properties of SFC this dilemma could be an excellent example.

A reduction by friction to the ground is often made. In Sweden the building regulation codes (BBK 04) allow for a reduction of steel area to be only 70 % when the friction coefficient is exceeding or equal to 100%, (see Figure 3.7).

- In one hand the friction may be sufficient for stress redistribution and there will be a well-distributed crack pattern (complete crack arrestment).
- In the other hand lack of friction leads to, what can be seen as randomly, distributed larger cracking as the stresses release.

3.3. FAILURE MECHANISMS AND SERVICEABILITY CONDITIONS

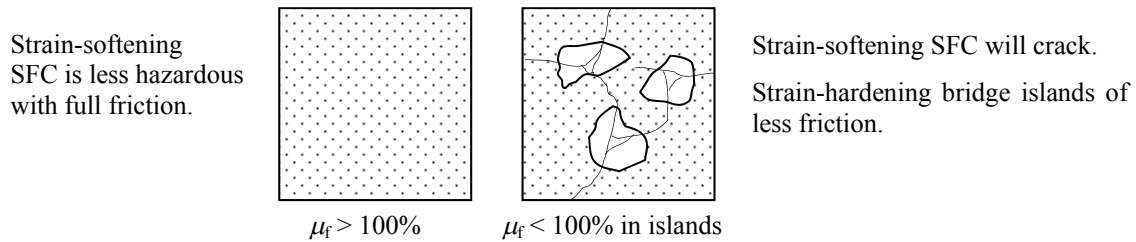

Figure 3.7: A slab with friction coefficient to ground larger than $\mu_f = 100\%$ may not suffer from large cracking with strain softening SFC (left). The friction free islands are potential risk zones for cracking in a strain softening concrete (right).

In the first case the crack redistribution may be 100 % even if the concrete is “only” strain softening. In the second case the concrete need to be strain hardening to redistribute cracks fully. Spots that are free from ground friction underneath the concrete slab may cause shrinkage cracking also from “restrained islands” if the slab is suffering from rapid desiccation. This latter case is often the fact when it comes to pile supported floors in the long term perspective.

Even when the friction is 100 % in the first part of the slab’s life, the piles will stand still when the substructure settles. This means that the restraint will change from uniform to uneven. This dilemma is a vital point and often a forgotten issue. When cracking occurs in a strain softening SFC or a concrete slab with less than minimum reinforcement, one cause is un-qualified reduction due to friction or uneven ground preparation.

In similarity a strain hardening SFC structure should not have any problem to re-distribute stresses if there is “room” for stress re-distribution – meaning that the global stress/strain level does not exceed the capacity of the SFC even if stresses locally are higher and thereby distributed. The rotational capacity in yield lines and yield zones must also be sufficient (BBK 04, 2004) and SS-EN 1992-1-1 (1992).

Combined reinforcement

Refinement of the cracking nearby the reinforcement bars is beneficial for the distribution of peak moments or shears. However the bond-slip of reinforcement bars is not significantly influenced by the addition of fibres (Schumacher et al., 2009). SFC is expected to increase the reinforced section’s capacity by crack refinement.

The limited ability of SFC to handle moments in a local section analysis does not mean that the global response is small. The contribution from fibres in concrete is expected to further increase the overall performance of the reinforced structure by the SFC’s stress redistribution properties. What has been noticed by several researchers e.g. Löfgren (2005) and Døssland (2008) also the performance of the two measures is expected to be larger than the performance of the pure superposition of the two measures in separate action.

3.4. Time-dependent properties of concrete and fibre concrete

General criteria's for good long-term behaviour

In Eurocode 2 two criteria for the deflection are given, obtained from ISO 4356.

- The appearance and utility could be impaired when the calculated sag of a slab under quasi-permanent loads exceeds span/250.
- Also the deflections that could damage adjacent part of the structure should normally be limited to span/500.

Also there is a criterion in Eurocode 2 where the ratio of slab thickness to span length is given certain limits. This is a simple approach that frequently is used for pile-supported SFC slabs. Since it originally is developed only for reinforced concrete slabs it should therefore be used with care for SFC without any further research as the limits then might be uncertain and even invalid.

According to the Swedish Concrete Manual (1997) there is a special rule for slabs. The deformations are considered to be sufficiently small if:

$$h \geq h_{\min} = 2.1 \sqrt{\frac{m_f}{k \cdot f_{ct}}} \quad (3.2)$$

where m_f is the largest field moment and f_{ct} is the concrete tensile strength and k is a graphed size factor that depends on concrete strength. Also the deformation is recommended to be limited to 1/400 of the span in serviceability limit state.

Creep dependent deformations

Creep of concrete may be treated with simplified methods or more advanced method taking Creep of concrete may be treated with simplified methods or more advanced methods taking the elastic hardening behaviour into account. In this area several researches have proposed formulations e.g. Bažant & Panula (1978), Bažant & Chen (1985) and Emborg (1989). The proposed models are thoroughly examined by Carlsvärd (2006).

Altoubat and Lange (2003) present new insights into the creep of FRC. They mean that the total creep strain must be considered as the sum of tensile basic creep and drying creep. And that the behaviour of creep in FRC is different than creep in ordinary concrete. In a study with fibre addition of a volume fraction of 0.5 % this influenced the individual components of tensile creep in different manners.

Steel fibers reduce the initial rate of tensile basic creep, but increase long term basic creep capacity, which suggests that fibres provide more stress relaxation in time. This is attributed to the ability of fibres to control micro cracking, distribute internal stresses more uniformly and engage greater volume of the matrix in stress transfer. More importantly, the fibres substantially reduced the micro cracking component of the drying creep, a component that is detrimental because of the damage associated with the deformation. To avoid confusion in

3.5. PREVIOUS STUDIES ON PILE SUPPORTED SLABS AND FLATS SLABS

interpreting the stress relaxation of FRC from total tensile creep and drying creep test results, this study suggests dividing the stress relaxation mechanisms into beneficial and detrimental components. (Altoubat and Lange, 2003).

The results provided by Altoubat and Lange explain why FRC has the ability to delay cracking due to drying shrinkage.

Hereby the mechanisms behind deformation of the concrete are beneficial and the creep associated by micro-cracking that damage the concrete in micro-scale is detrimental. Basic creep and stress-induced shrinkage is the main factors behind creep of FRC; this is considered to be advantageous. Ordinary concrete creep suffers from a substantial part of micro-cracking that is detrimental.

Proposal for a method of calculation the long-term deflection due to creep

In Paper D a method that is based on Eurocode 2's appendix B is proposed. The method suggests using the cumulative relative humidity and temperatures measured in the area over time and to use the theory of elasticity to calculate the slab deflection, see **Paper D**. A 90 % reduction of stiffness compared to plain concrete was used in the analysis to achieve a satisfactory agreement on calculated deflections to measured deflections. The 90 % reductions corresponds also to standard tests on SFC beams showing a 10 times increase in deflection after cracking, Silfwerbrand & Hedebratt (2013).

3.5. Previous studies on pile supported slabs and flats slabs

Studies on flat slabs have been performed by a few researchers at universities, often with initiative taken by steel fibre supplying companies. Several full-scale tests have frequently been reported on conferences and in journals by the fibre supplying companies but very few are reported scientifically as papers from universities. Findings of reported studies are briefly presented in this section.

TU Braunschweig (1999)

Large scale test where conducted at TU Braunschweig (Falkner and Gossila, 1999). The test-slabs consisted of SFC with 40 kg/m^3 of hooked end fibres RC-80/60-BN (ZC 60/0.75) and reinforcement according to Figure 3.8 and Figure 3.9. The concrete was according to Eurocode 2 of quality C30/37 (35 MPa in cubic compressive strength). Three slabs where tested, whereas the SFRC slab failed with no load increase after developing a yield line. The SFRC/RC slab and the SFRC/prestressed slab showed ductile behaviour. The dimensions $5.0 \times 5.0 \text{ m}$, span $2.0 \times 2.0 \text{ m}$ and was loaded by a hydraulic jack in each panels centre. The diameter of the concrete piles where 200 mm.

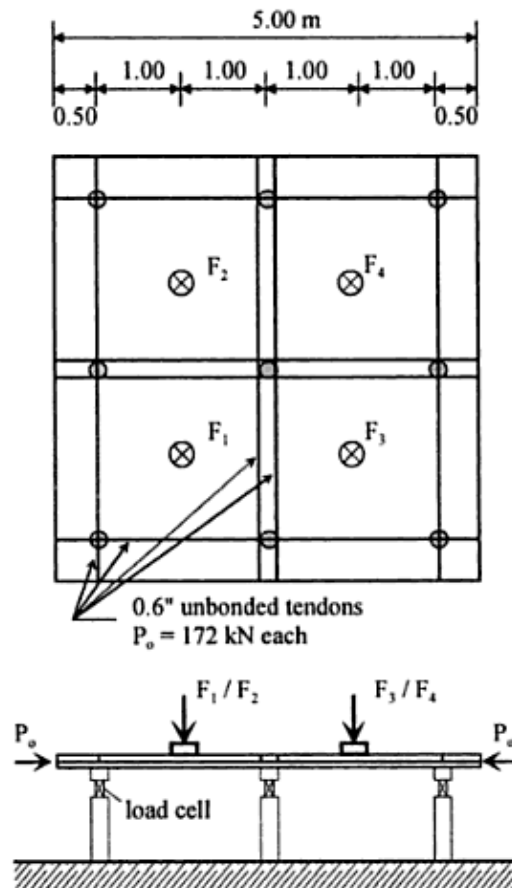

Figure 3.8: Test set-up for pile-supported slabs. (Falkner, 1999).

The reinforcement ratio was 0.1 % for the total slab (with fibres excluded) and the maximum reinforcement ratio in the strip sections was 0.19 %. The thickness was not presented in the paper but is given as 140 mm in the U.S. patent of Thoof et al. (2001), the spacing of reinforcement is not presented. The fibre content was 0.51 %.

The slab was also loaded by taking away some of the supports simulating uneven settlements. A nonlinear analysis of cracking, post cracking and crushing capability was carried out in the finite element program ANSYS on a quarter piece model due to symmetry. Falkner and Gossila suggest that verification on serviceability condition is required for several areas of applications. They also suggest a standardized reinforcement system to be used and that a pre-stressing of 1.5 MPa can eliminate most of the traditional reinforcement. The load-deformation relation was not presented but measured with LVTDs at 16 points, also the concrete strains were measured using strain gauges.

The crack patterns in Figure 3.9 are much alike those presented in **Paper C**, also the reinforcement is similar but without stirrups in reinforcement beams.

3.5. PREVIOUS STUDIES ON PILE SUPPORTED SLABS AND FLATS SLABS

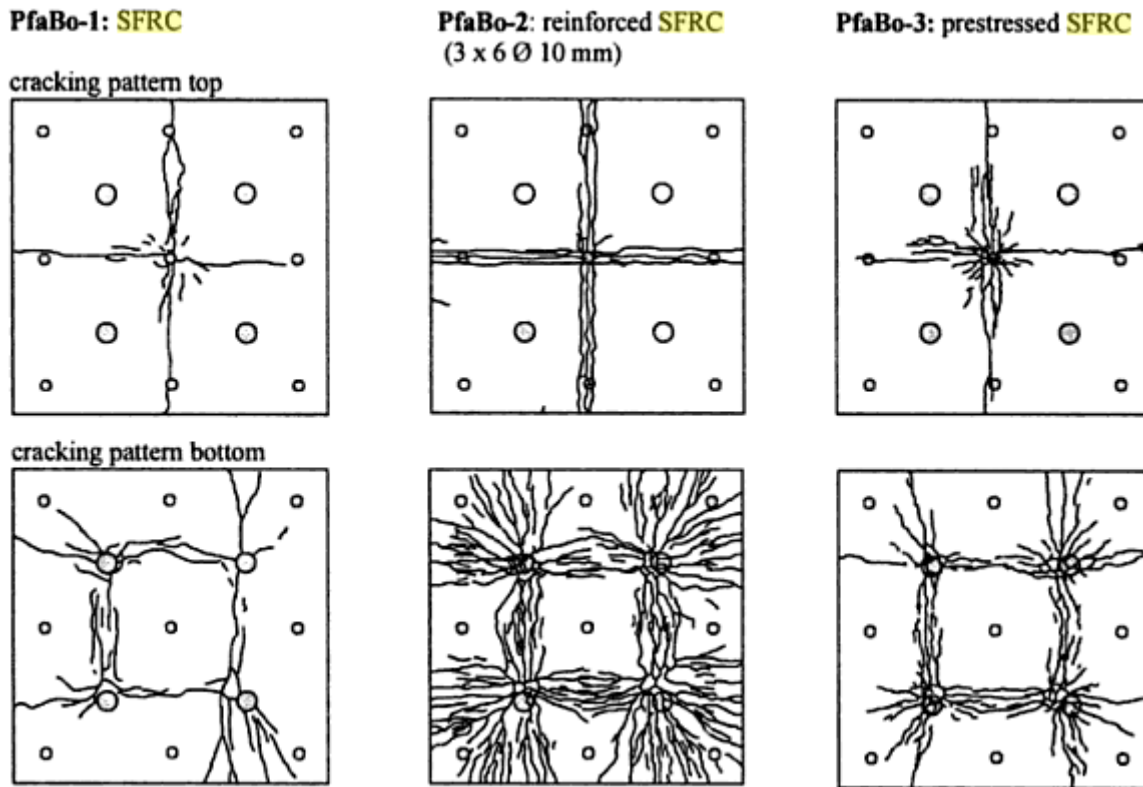

Figure 3.9: Crack pattern of different slab systems. (Falkner, 1999)

However in the U.S. patent Thooft et al. (2001) one can find more information on the large scale test. As reference they tested a slab with B45 and the invention hold B35 which would be similar to a C35/45 and a C28/35 (according to NEN 8005 /NEN-EN206-1). The concrete specification is shown in Table 3.1.

The loadings were discontinuous with a number of load incremental load steps of 10 kN each and also steps where the loadings were interrupted or hold constant for a few hours, as seen in Figure 3.10. The maximum calculated breaking (failure) loads and experimental loadings and belonging deflections are comparably less than in the present study in **Paper C**, as seen in table 3.2. This could be explained by e.g. differences in the concrete mix and the support conditions.

Table 3.1: Concrete specification for the tests performed at TU Braunschweig, Thoof et al. (2001).

	Reference	Invention
concrete quality	B45	B35
steel fibres DRAMIX® length 60 mm, 0.75 mm diameter	40 kg/m ³	40 kg/m ³
cement CEM I 32.5 R (PZ 35 F) Teutonia	360 kg/m ³	360 kg/m ³
fly ashes	100 kg/m ³	100 kg/m ³
water/cement ratio	0.46	0.53
water	165 l/m ³	191 l/m ³
sand Evers 0/2	703 kg/m ³	681 kg/m ³
fine gravel 2/8	279 kg/m ³	280 kg/m ³
small lime stone 8/16	766 kg/m ³	748 kg/m ³
liquid Isola	0.5%	0.5%
retarder Isola PH	0.2%	0.2%
cage reinforcement	No	Yes
		4 vol. %

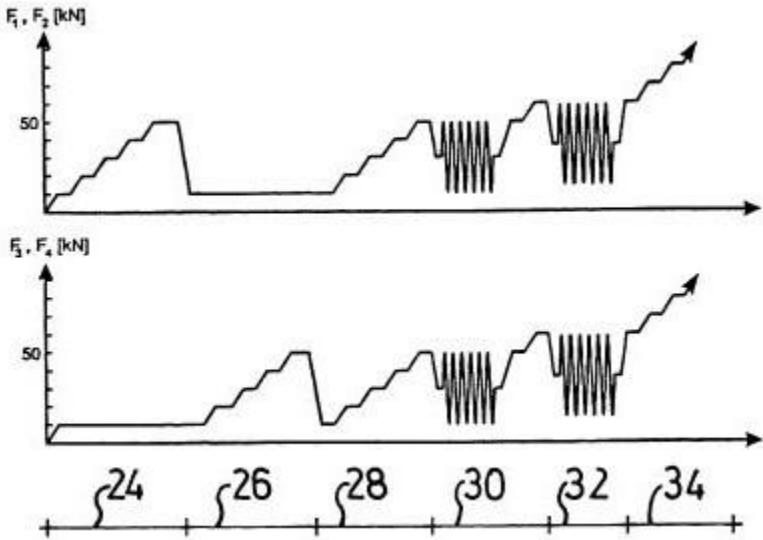

Figure 3.10: Loading scheme. The picture illustrates course of various loads applied to the inventions and the fixed structure. (Thoof et al., 2001)

3.5. PREVIOUS STUDIES ON PILE SUPPORTED SLABS AND FLATS SLABS

Table 3.2: Results from loading for the tests performed at TU Braunschweig. (Thoof et al., 2001)

	reference	invention
<u>calculated breaking load (kN)</u>		
symmetrical fracture lines	69.4	128
asymmetrical fracture lines	72.8	137
experimental breaking load (kN)	81.6	129.9
bending at maximum load (mm)	3	42

Steel fibre only reinforced slab Luxemburg (2001)

The test here referred as Luxemburg (2001) was conducted by TrefilArbed (now ArcelorMittal), see Figure 3.11. In an article in the English magazine Concrete by Destrée (2001) he stated that, pile supported slabs with a combination of steel bar reinforcement and steel fibre concrete constitute a wide spread system that had been used and developed for a decade already, and that over 5 million m² of floors were constructed with solely fibre concrete worldwide



Figure 3.11: Full-scale loading with a centre load applied with a loading frame. (Destrée, 2001)

He further stated that it is common to use a fibre addition of 40, 45 and 50 kg/m³, this with the fibre, Tabix Plus (1 mm diameter, 60 mm of length and 1500 MPa in steel compressive

strength) or Twincone fibre (1 mm diameter, 54 mm of length and 1100 MPa in steel compressive strength) in the SFRC floors without reinforcement bars. Comment: the strength of steel is most often in this use given in tensile strength rather than the compressive strength.

The loading of a 160 mm SFC slab containing 45 kg/m³ where the slab rested on a slab grid is concluded in the article by Destrée. The dimensions were 9.7 × 9.70 m in sides, the spans were 2.0 × 2.0 m and the slab was loaded by a hydraulic jack in the panel centres. The cross-sectional dimensions of the square concrete piles were 210 × 210 mm. The main results from loadings are briefly presented in Table 3.3.

Table 3.3: Results from the tests performed in Luxembourg. (Destrée, 2001)

	Maximum service loading intensity (kN)	Experimental loading at first crack (kN)	Ultimate loading (kN)
Case 1: Central span	75	110–220	430
Case 2: Corner span	50	80	180

FRC Slabs in Rena, Norway 2004

In the PhD project “Fibre Reinforced Concrete in Load Carrying Structures”, Døssland has reported Norwegian studies on SFC structures. Three slabs in a fibre reinforced concrete (FRC) house were subjected to full-scale load testing. Two slabs with similar length-to-width ratio 1.1, with dimensions 3.0 × 3.4 × 0.15 m were tested. One of them was traditionally reinforced with a minimum of reinforcement according to Norwegian Design rules for reinforced (plain according to Døssland) concrete NS3473 and one steel fibre only. Also a slab with different length-to-width ratio 2.3, with dimension 3.0 × 7.0 × 0.15 m was tested. (See Figure 3.12 and 3.13).

3.5. PREVIOUS STUDIES ON PILE SUPPORTED SLABS AND FLATS SLABS

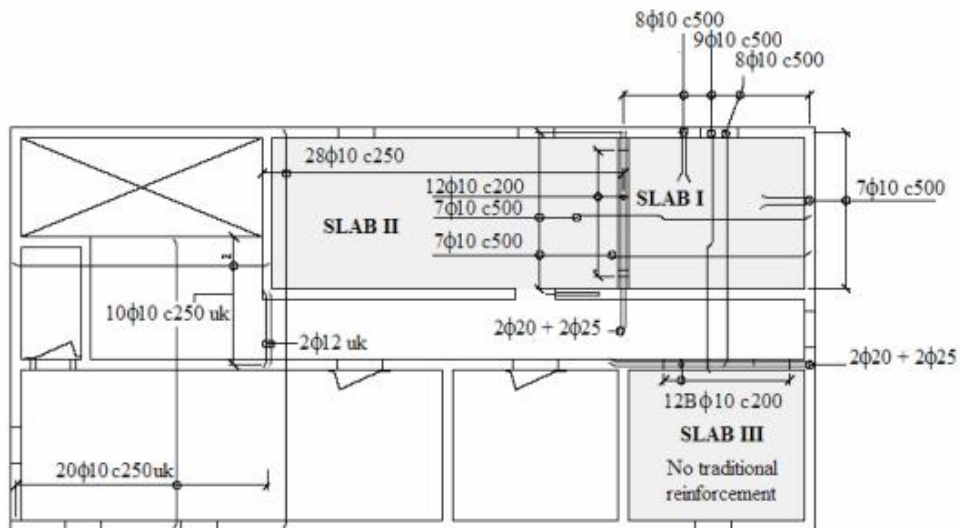

Figure 3.12: Reinforcement drawing of the tested slabs in the FRC concrete house in Rena, Norway, 2004. (Døssland, 2008)

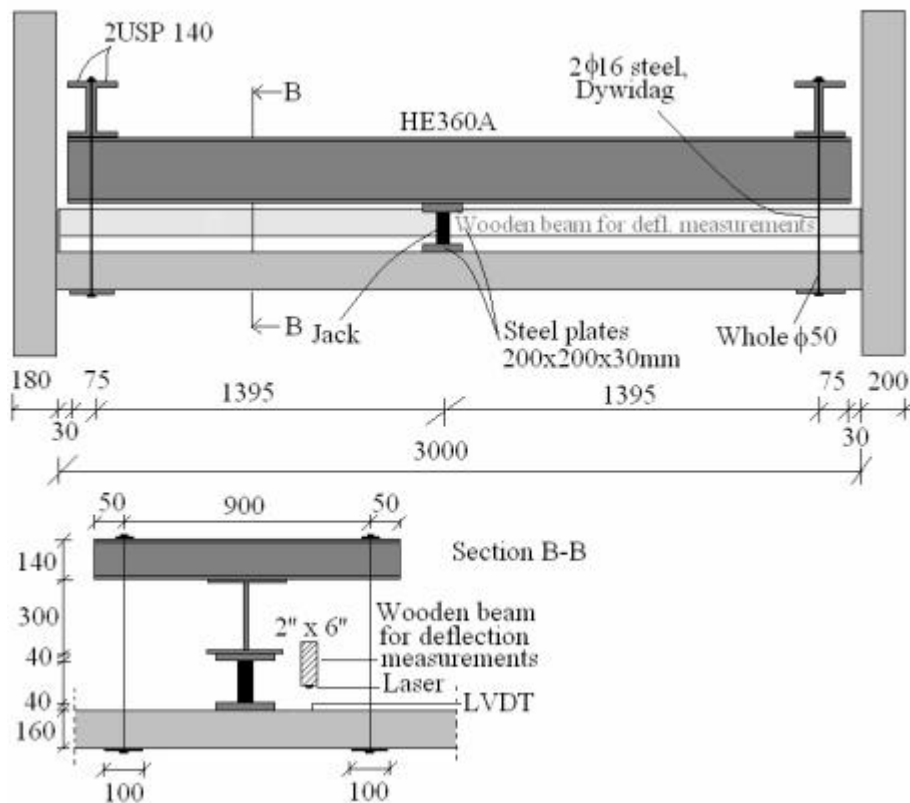

Figure 3.13: Principal test set-up, Rena, Norway, 2004. (Døssland, 2008)

CHAPTER 3. PILE SUPPORTED SLABS - THE DESIGN MATTERS

The slabs were supported at the edges and at internal concrete walls (of fibre only concrete). The wall connection was with stirrups jointing the wall and slab. The content of fibres was 62 kg/m³ of the fibre Dramix RC-65/60-BN.

The finite element analysis (FEA) seems to be in good agreement with the measurements even if the maximum FEM peak loads occur before the actual structure seems to fail. The loadings were stopped at a certain level of displacement or before the final failure loads to preserve the slab for the owner. Data from the tests as reported in her doctoral thesis (Døssland, 2008) are presented in Table 3.4 and 3.5.

Table 3.4: Properties in fresh and hardened state. (Døssland, 2008)

Density	Air	Temperature	Slump flow	Cube strength (28d)
2319 kg/m ³	6.0 %	25°C	550 mm	45.91 MPa

Table 3.5: Maximum achieved load/displacements for the short term testing. The maximum loads are given with respect to values on displacement dependent on the measuring equipment used according to Figure 3.13 and 3.14, from (Døssland, 2008).

Test no	Position	Date of construction	Maximum Load/displ. [kN]/[mm]	FEM Load/displ. [kN]/[mm]	Fibre content+ reinforcement [kg/m ³]+(bars)
Slab 1	Centre	July 2004	305 / 5.2, 6.4	350/10	62+(# Ø10s250)
Slab 2	Centre	July 2004	400/9.1, 10.2, 12.3, 14.4	405/13	62+(# Ø10s250)
Slab 3	Centre	July 2004	450/11.1, 12.2, 13.3, 16.4	425/11	62 + (0)

3.5. PREVIOUS STUDIES ON PILE SUPPORTED SLABS AND FLATS SLABS

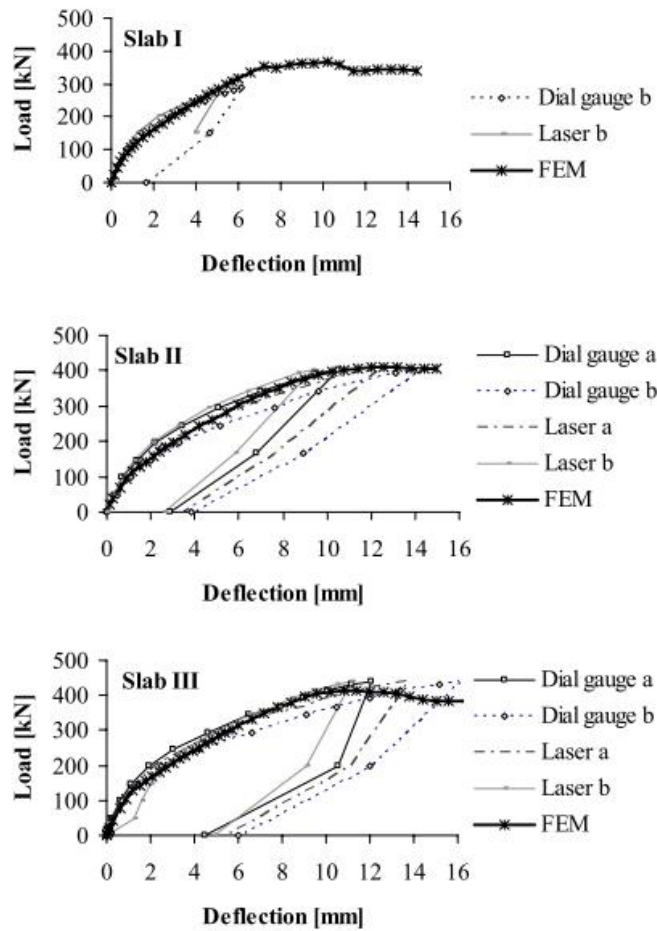

Figure 3.14: Load deflection curves for three different load combinations of slab size/reinforcement ratio. (Døssland, 2008)

Elevated slab in Bissen, Luxemburg 2004-2005

Studies have been performed by e.g. Gossia (2006) where short term performance for a serviceability limit state and the ultimate load capacity were tested on a 340 m² flat slab at Trefilarbeid in Bissen, Luxemburg (Figure 3.15-3.18). The test was conducted in 2005 by ArcelorMittal in conjunction with the Technical University FH Aachen. The short term performance for a serviceability limit state (SLS) was tested by checkerboard placing of water tank loads and the ultimate limit state (ULS) maximum load capacity was tested by hydraulic loadings. The test slab was constructed with a concrete mixture containing 1.3 mm diameter, 50 mm long crimped steel fibres at a dosage rate of 100 kg/m³.

The slab had the thickness 200 mm and 3 × 3 spans of 6.0 × 6.0 m, in total 18.3 × 18.3 m. The thickness was 200 mm. The slab was simply supported by 300 × 300 mm flat steel plates on top of steel columns. The first crack occurred at central span for 230 kN at 7 mm displacement and at edge span for 160 kN at 7 mm displacement, at corner span for 120 kN at 8 mm displacement.

CHAPTER 3. PILE SUPPORTED SLABS - THE DESIGN MATTERS

The maximum capacities was at central span 461 kN at 50 mm displacement, at edge span 265 kN at 50-80 mm displacement, at corner span 215 kN at 50 mm displacement, Gossila (2006). See also Table 3.6 and Table 3.7. The encouraging results showed very high ductility of this high-performance steel fibre-reinforced concrete (HPSFRC), according to Ošlejs (2008). Also Destrée & Mandl (2008) and Mobasher & Soranakom & Destrée (2007) have reported the tests.

Table 3.6: Maximum load and deflections. (Destrée, 2004)

	Central span	Edge span	Corner span
First crack	230kN	160kNn	120kN
First crack deflexion	7mm	6mm	6mm
Max. load	470kN	260kN	220kN
Max. plastic deflexion	65mm	120mm	260mm at 150kN.



Figure 3.15: Hydraulic loading at centre span to the left and loading with “service load” to the right. (Destrée, 2008).

3.5. PREVIOUS STUDIES ON PILE SUPPORTED SLABS AND FLATS SLABS

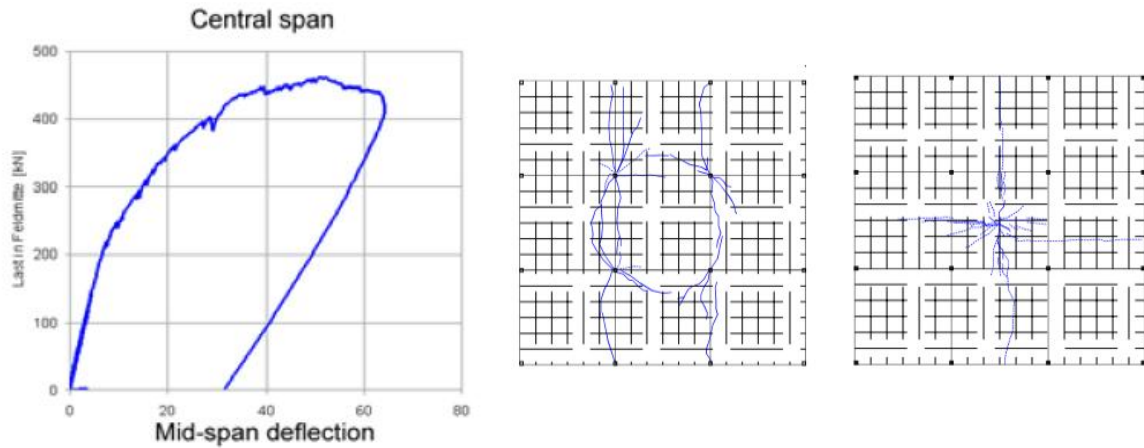

Figure 3.16: Load-deformation curve and (central of slab) the crack pattern from loading at central span, left top and right bottom. (Destrée, 2004).

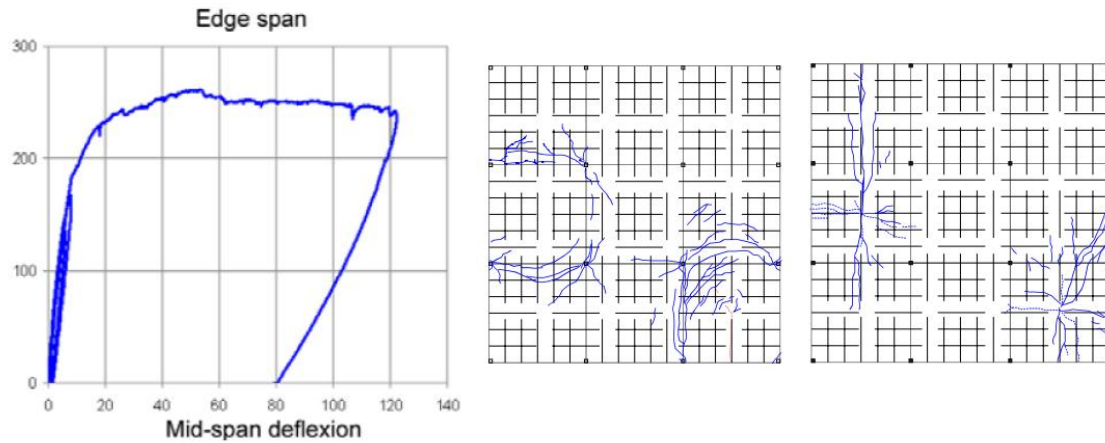

Figure 3.17: Load-deformation curve and (left-middle of slab) crack pattern from loading at edge span, left top and right bottom. (Destrée, 2004).

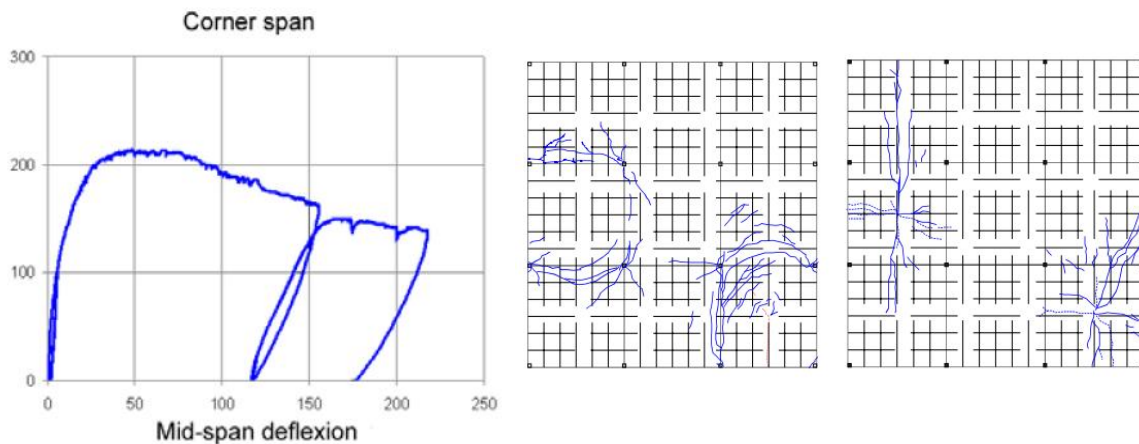

Figure 3.18: Load-deformation curve and (down-right of slab) crack pattern from loading at corner span, left top and right bottom. (Destrée, 2004).

Elevated slab in Tallin, Estonia 2007

Also there has been a test conducted by ArselorMittal in Tallin, Estonia, similar to the test that were made in Bissen, Luxembourg (Figure 3.15) with the difference of fewer spans and columns consisting of concrete. Obviously the test was more directed towards elevated flats slabs than to pile-supported floors. Figure 3.19 shows the conduction of the test and Figure 3.20 shows the load-deflection curve from the loading and Table 3.6 shows results from the two tests. The results and pictures have been taken from papers and materials handed over from Mr Destrée.



Figure 3.19: Hydraulic loading at centre span to the left and loading with “service load” to the right. (Destrée, 2008).

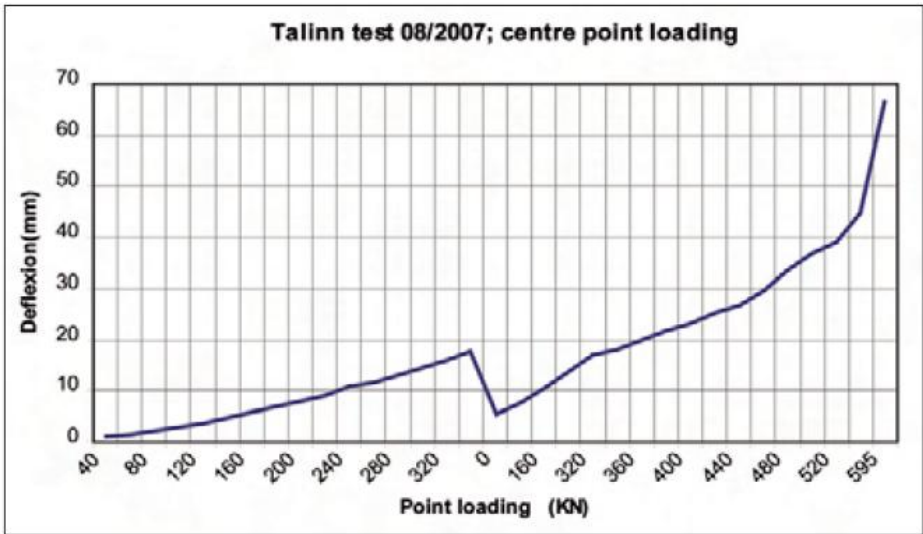

Figure 3.20: Results from load-deformation test - loading at centre span. (Destrée, 2008).

3.5. PREVIOUS STUDIES ON PILE SUPPORTED SLABS AND FLATS SLABS

Table 3.7: Maximum achieved load for short term testing. Test according to Figures 3.15-3.19. (Destrée, 2008).

	SERVICE		LIMIT of CRACKING		ULTIMATE	
	max loads (SLS) F.E.M. design Bissen Tallinn		Experim. loads at first crack Bissen Tallinn		Experimental Ultimate loads Bissen Tallinn	
	kN/m ² <i>U.D.L.</i>	kN* <i>P.L.</i>	kN* <i>P.L.</i>		kN* <i>P.L.</i>	
1: mid span	7 / 110*	9 / 100*	200*	125*	470*	600*
2: corner sp.	4 / 60*	6 / 60*	140*	80*	230*	320*

Elevated slab in Riga, Latvia 2008

In Riga, Latvia, an elevated slab over a basement was built in 2008. This was the first such slab built in Latvia, and then in the private residence of one of their owners. The free span reached 4 m, and a 160 mm thick slab with 100 kg/m³ of 1.3 mm diameter, 50 mm long crimped steel fibres in 35 MPa concrete was used, Ošlejs (2008).

The site was visited during a SIS/TK190-AG2 group meeting by the author and other members of the group. There seems not to be any scientific evaluation of this project.

Elevated slab in Daugavpils, Latvia 2008

A 250 mm thick slab was cast for a Ditton-nam supermarket in Daugavpils, Latvia, that covers a basement and is supported on a 6 × 6 m column grid. The 1042 m² of floor slab contains 100 kg/m³ of 1.3 × 50 mm crimped steel fibres and was constructed to test the load-bearing characteristics of the Ditton-nam supermarket HPSFRC slab.

In contrast to industrial slabs-on-piles, where the actual floor contractor does not use any steel bars, the investigators do use a small amount of traditional steel bars in residential and commercial suspended slabs as anti-progressive collapse reinforcement. (Ošlejs, 2008)

This provides according to the company an additional level of safety in case of catastrophic collapse of a supporting column. The testing was performed under supervision of Riga Technical University (i.e. Udris), but currently no reports have been presented according to Destrée. The service load of 4 kN/m² was mimicked using pools filled with water on top of the slabs at all three floors of the supermarket. The maximum deflection was only 2.8 mm. The slab retained its elasticity, returning to the initial elevation after the load was removed Ošlejs (2008).



Figure 3.21: These flat slabs in several levels, was loaded with “service load”. (Destrée & Mandle, 2008).

Full-scale tests on one-way suspended SFC slabs in Eindhoven 2010

Full-scale tests on suspended one-way slabs have been performed in Eindhoven during the summer of 2010 by the designer Menting, ABT and Kleinman, TU Eindhoven, (Tissink, 2010a, 2010b). The test were not finalized in August 2012, results are therefore not yet reported scientifically.



Figure 3.22: Loading of slab. Photo: Anne Hoekstra (2011).



Figure 3.23: The gravitational loading was 1.0 ton/m^2 / $w_{\text{direct}} = 3 \text{ mm}$, $w_{1\text{day}} = 10 \text{ mm}$ and at 1.3 ton/m^2 the failure was sudden. (Tissink, 2011a).

Discussion

An important difference between the tests is the number of spans. In several test the spans are either 2 or 3. In the 2-spans there are no middle (centre) panel. Also the actual support condition varies. The test by Falkner & Gossila (1999) at TU Braunschweig has as support load cells that probably were used for registration of the loads. It is not shown how the loads are applied. In other tests, a loading frame is used to apply the mid-point load e.g. Luxembourg, Bissen, Tallin and Riga. The test in Rena by Døssland (2008) may not be considered as a rigid frame due to the Dywidag tendons used. The supports are ranging from e.g. load cells, stiff steel columns, stiff concrete columns, and interconnected walls and slabs.

In the following tests, in this chapter, with frames, the arch and membrane action is from double restraints i.e. (i) the stiff steel frame and (ii) the surrounding slab. The frame can in two separate actions effect the slab, depending on the stiffness of the frame, but only in one direction.

(1) the frame can induce arch action due to lateral restraining the slab or

(2) the frame can induce membrane action when the bow frame is bending and the ends are pressing out the supports laterally.

A situation in-between is not likely to occur due to the bending of the bow frame is due to the applied load. A stiff frame induces both arch and membrane action and a less stiff bow frame is causing membrane action as the supports are pressed out. Also the frame may hinder the rotation at the supports in one direction. Loading by restraining frame and hydraulic loads on

the slab makes the testing statically more indeterminate than before and of less value because there exists no mechanical simple solution to this bow frame-slab problem that consists of both a beam and a plate and also stiff columns. This may not have been considered in the analysis of calculated failure loads. However the energy absorption is shown to be large as the flat slabs may carry large loads and tolerate large deflections.

In the testing in Rena by Døssland the maximum loads were around 350–450 kN at about 11 to 16 mm displacement. The deflections are rather small even if the loadings are at high level in this study compared with the other test in the chapter 3.5, also in comparison with the test in **Paper C**. The loadings of slab 1 and slab 2 resulted in about 350 to 400kN respectively but in fact the SFC slab with no reinforcement was stronger and responded with similar stiffness. Probably the results from all three test slabs is proof of a large arch and membrane action that was not so pronounced in the other tests. The rotational stiffness seems also to increase rapidly with the rate of end fixation. However the FEM analyses were made with both 100 % restrained and 50 % restrained rotation and this is proposed to not influence on the arch action as much as a lateral restraint.

The cement in the first large scale test was pure Portland cement (CEM I) see Table 3.1, in Sweden often used in civil engineering structures building, bridges and so on, where the concrete is needed to have a slow but stable maturing. Later tests may have been performed with CEM II, which is not known from the references. The introduction of house building cement CEM II (Byggcement) in the following years after 2000 started to be common even in floor construction instead of the used Standard cement type. The CEM II “Byggcement” was used in the main part of the projects in **Paper B** and in the full-scale test presented in **Paper C** and **Paper D**. The changes of cement ought to make a difference in test results as the fibres may have an effect in the early development of micro-cracking, therefore anyone who makes comparisons of the tests must also include the possible effect of changed cement type.

The crack strength ranges from 80 to 220 kN in the Luxemburg test and the ultimate loading is 180 to 430 kN in corner respectively central span. This large deviance in first crack load was not obvious in the present study in **Paper C**.

There is a common denominator between some of the tests performed by certain companies and the actual executed floors (in commerce). It seems that the first crack load that was derived by tests is utilized together with a safety factor for serviceability in real projects. Then the fibre concrete is not used in design as the service condition is based on the crack load where the fibres do not contribute to the strength. The safety margin is the difference between the tested ultimate loads from short term tests and the design load. Also the some test may be highly indeterminate and impossible to correlate with a mechanical model.

In the previous sections eight full scale tests on elevated SFC slabs are summarized. Generally, the slabs have performed well and developed a real load-carrying capacity that substantially exceeds the loads given by elastic limits. In most cases the slabs are supported by continuous supports from load-carrying walls. In all cases the loading is limited to short-term loading. Consequently, there is a need to investigate pile-supported or column-supported slabs for both short-term and long-term loading. This is done in current research; see **Paper C** and **Paper D**, respectively. Furthermore, the most slab tests have been conducted by steel

3.5. PREVIOUS STUDIES ON PILE SUPPORTED SLABS AND FLATS SLABS

fibre producers or contractors closely co-operating with these producers which usually means that both the descriptions and the analysis of the test are limited.

Chapter 4

The research work

4.1. Introduction

Apparently there is a troublesome work for clients in decision making when summing up and scrutinising their own demands when making an order on a brand new industrial concrete floor for the new building they build, also for the contractor or designer (which now came first in mind for the client to call). However, the results in this affair have not resulted in better performing floors since 1970. The damages in floors are often visible for the client's eye and consist mostly of different kinds of cracking, edge rising, surface damages or biases from a perfect or expected surface. The number of damages varies to almost perfectly match the conjuncture curves. This was confirmed in the study made by Johansson (2003) and is treated in **Paper A** and also confirmed by the **Paper B** for later years.

In the work preceding the licentiate thesis demands on industrial floors were studied and presented in a report (Hedebratt, 2001) and as two conference papers (*Integrated Design and Construction of Industrial Floors Demands on industrial floors and a pilot study on shrinkage strain*). This work and the findings have also been reported at several conferences and workshops (see p. xi) and used as part in continuation education courses at the Swedish Cement and Concrete Research Institute, Tyréns, NCC and Skanska.

4.2. Description of the working process

Following the initial study on demands three pilot studies were conducted on full-scale productions of steel fibre concrete industrial floors. The first one was a ground supported slab whilst the two other floors had large areas where the floor slab was pile supported. For all three floor productions the author conducted extensive studies on the construction works and how the design related to the construction process. A long-term measuring study over 224 days was conducted for the three slabs and also with reference beams according to SS 13 72 15. The results from the measuring study revealed that present predominant concrete type (C30/37) in fact shows large drying shrinkage and that the measured mean final shrinkage ϵ_{sh}

was 0.9-1.1 ‰ and already after one year the floor shrinkage was in level of what is recommended in the Swedish design code BBK 04 (2004). Before and during the two final floor productions various measures were taken to improve the quality of the floors and to improve labour situation, interest, knowledge base and mutual feedback. An integrated method for design and construction was developed to improve the quality of the floors.

The work with the pilot studies resulted in three technical reports, Hedebratt (2003b), whereof pilot studies II and III were condensed into a Licentiate thesis, Hedebratt (2004), and presented on a licentiate seminar in February 2005.

Meanwhile the SFRC flooring project was experienced their all-time high market development, year 2001-2006, and the mobile concrete stations were taking market shares in Sweden, the author was contacted by the current CEO of the Swedish Ready-Mix Concrete Association Mr. Evert Sandahl to discuss how the Swedish mobile concrete station entrepreneurs could be helped to deliver certified factory standard concrete and to improve the quality measures of such concrete. The author was even invited as head speaker on a seminar (2005) for managing ready-mix concrete station operators, to talk about the flooring industry and sources for quality improvement. The entrepreneurs were later on gathered under the Swedish Mobile Concrete Association. Many of the SFC floors constructed under this period are described in **Paper B**.

Together we also took initiative to invite members to start at working group on SIS discussing and following the development on un-traditional reinforcement methods. The group has now developed into SIS/TK556 AG1 *FRC Design* and is near a standard draft. Also later the author and Professor Johan Silfwerbrand took part in discussion on how to start a SCA committee on industrial floors (2004). Four years later it resulted in the SCA report on industrial concrete floors which **Paper B** is part of.

The work following the Licentiate thesis was mainly from the author's own large interest in this field, and the inspiring thoughts were initiated from the work at Tyréns and SCA, and focused on problems experienced in the earlier design processes. Together with Professor Johan Silfwerbrand the author worked out a plan to perform full-scale tests on steel fibre reinforced pile supported floor slabs. Utterly the work should lead to better performing floors and an overall improvement of the building process.

The full-scale testing was planned and ready to start in at least three occasions in three different places of the country before it was decided to start on an old summerhouse lot in Enhagen, Västerås. A friend offered the author to perform the short-term and long-term testing on his newly acquired estate. In exchange he wanted to take over the experimental building, as it is, after completed testing. This was an offer that the author could not disregard due to the only 7 km travel distance from his own home, now used to travel 220 km by train each day back and forth from work and the opportunity to save money on tearing down the experiment and recycle the site. The full-scale test was a success in such a way that it really shows how redundant SFC structural flat slab construction could be and that also in much severe conditions than often are apparent in reality for pile supported SFC slabs. The execution and analysis of the full-scale testing is described in **Paper C** and **Paper D**. The first part of the full-scale testing is described from building up of the test site (the house) further on the paper explains the test set-up and equipment and some of the material testing. In order to

perform the testing the author has planned, designed and project managed and taken part of the construction of the full-scale experiment and the material testing. The work preceding the testing is valued to about 1000 hours.

The research work covers the short-term loading of the elevated flat slab and some of the material sampling and testing. Further the sampled test results are analysed. The testing of column supported first floor of the house was conducted with assistant of KTH laboratory staff. Part of the material testing was conducted in Bekaert laboratory in Kortrijk, Belgium, and part at Swedish Cement and Concrete Research Institute in Stockholm, Sweden.

The initial stages of planning and the intensions of the full-scale test have been presented at International Symposium on *Innovation & Sustainability of Structures in Civil Engineering-Including Seismic Engineering*, November 20--22, 2005, Nanjing, China and Nordic Mini-Seminar 2007: *Fibre reinforced concrete structures* hosted by NTNU Department of structural engineering and SINTEF Building and Infrastructure. Part of the results was later presented in a short paper and on a poster at the International fib Symposium 2008: *Tailor Made Concrete Structures New Solutions For Our Society* hosted by Joost Walraven and Dick Stoelhorst in Amsterdam, The Netherlands, and at the XXth Symposium on Nordic Concrete Research & Development in June 2008 in Bålsta, Sweden.

For the long-term testing the author together with the co-author invented a test mechanism (not patented). The design and construction of the test equipment were by the author, including welding and assembling of equipment (lever mechanism) and casting of weights. The manual sampling of read-outs on place where conducted during one hole year. After that analysis and writing of the paper took place. The analysis and the paper were written at Swedish Cement and Concrete Research Institute during a 7 month leave of absence from Tyréns from the 1st of November 2011 to the 31st of May 2012.

4.3. Summary of appended papers

The following is a brief summary of the appended papers.

In **Paper A**, *Damages*, the most frequent occurring damages and costs for repair are presented. Dividing the damages can be after (i) type, (ii) cause and (iii) consequence. The most common type of damage is cracking followed by insufficient strength and wear. A subdivision can thereafter be after cause. Plastic shrinkage and restrained shrinkage and are often causing cracks and curling comes from uneven moisture profile due to desiccation. Curling is often causing damages as illustrated in Figure 4.1. Besides damages, the occurring problems can be divested after consequences.

Damages in floors have during the author's years as consulting engineer at Tyréns been a natural recurrent consulting assignment. The paper was written as one chapter of the SCA committee work on the state-of-the-art report *Industrial Concrete Floors* (2008). The author recapitulated damage investigations and performed a theoretical study and made interviews with contractors and also other consultants performing damage investigations. The author has visited and inspected numerous of damaged floors. The author also took part on committee meetings as secretary. During and after the finalisation of the report continuation education

courses have been held at several occasions on the subject with material straight from the report. The courses e.g. the *Floor course* and company specific courses, have been held in the regime of the Swedish Cement and Concrete Research Institute.



Figure 4.1: Recurrent damages in investigated floors. To the left curling and cracking near joints and at corners. To the right curling that has been grinded ones and later levelled with topping screed. From **Paper A**.

In **Paper B**, *Lessons Learned – Swedish Design and Construction of Industrial Concrete Floors*, the research work treats 25 studied pile supported floors slabs that were designed and constructed with SFC. The reinforcement is put in strips over the pile rows, then constituting supporting and framing beams for the interior panels. The beams were designed according to the Swedish concrete code BBK 04 (2004) and the slabs in-between were designed according to SCA report No. 4. (1997). The method as it is, with combined reinforced beam across the perpendicular pile lines, is not a novel concept, a similar concept was described in earlier Bekaert Design guideline for pile supported floors which was originally tested at the University of Braunschweig in Germany, and in U.S. Patent 6,269,602 B1.

The first applications using this new patented combined SFRC/RC system were carried out in the Netherlands, Belgium, UK and Germany in early 1998, (Falkner, 1999).

The concept which is also described with design calculations for Eurocode 2 in Knapton (2003) was changed by the designer (Hedebratt) already in project No. 2. in **Paper B**. The change of the system was simply to eliminate the stirrups along each reinforcement cage and to exchange them with reinforcement chairs, to have the flexibility to freely lift the reinforcement in place, and to always be able to use reinforcement bars of full length (FL). These changes constituted a requirement from the contractor to be able to use automated construction equipment, in this case Laser-Arm® laser screeder and topping spreader to speed up working pace and reduce the labours' reinforcement work. The changes were later wider spread in design to other countries in the world, and have been used by the author in e.g. England, Denmark, Norway, Finland, Estonia, Iceland, and in projects covered by the **Paper**

B. These machines were previously only used for SFC ground slab floors but hereafter used in the majority of the floors in project No. 3 - No. 25.

The paper shows that design and construction of concrete floors always need a proper job planning with selection of material for a correct design solution with appropriate construction method. The steel fibre concrete concept has shown to give in overall an accepted quality of floors used with modern construction techniques. Of the 25 floors studied, during their present life that currently (2012) varies from 6 to 11 years, 11 of them have cracking in various extents. Only two of them have reported problems with levelness and only one has reported problems with joints. It seems to show that there is no problem with joints, however cracks are often following the joints and thereby caused by them. Of the 25 floors studied, 12 of the floors have no reported damages. This fact does not mean that there is no cracking existing in these floors as owners may value the damages and consequences differently. Only two floors were damaged severely, this due to overloading in the early life of the floors which seems to be an unusual situation (but common according to these typical clients).

The paper is a product of many years of work with frequently visits to many of the floors and also contacts with clients, material suppliers and contractors. From the paper a preliminary study was presented at the 6th Colloquium on Industrial Floors in 2007 in Esslingen, Germany.

The test slab constitutes the elevated slab in a family house and simulates a pile-supported industrial concrete floor slab in half scale. The slab was divided into four quarters enabling four combinations of two fibre contents (40 and 80 kg/m³) with and without additional reinforcing bars. The slab was loaded in 8 times in 8 different points resulting in 8 tests.

In **Paper C**, *Full Scale Test of a Pile Supported Steel Fibre Concrete Slab*, the loading of the structure demonstrated that the loading was near what the bearing capacity could manage without causing a brittle failure (in this case punching), but the maximum load was reached in all loadings before the tests were terminated. In two out of eight cases the punching failure may have occurred, in present cases as a sudden rupture.

The relatively small addition of bar strip reinforcement around the panels gave in general a substantial contribution of 22-32 %. The real fibre contents for the two main areas were 31.5-33.8 kg/m³ and 60.6-91.3 kg/m³, respectively. The tested slab showed that a redistribution of tensile stresses occurs both in panels where the slab sections is fibre only and where the panels are inscribed by strip reinforcement. The inscribing reinforcement seems to have stiffened the slab response in level of up to 2.2 times compared to the similar aligned slab panels without strip reinforcement. At the interior combined reinforced panel where the stiffness was lost at failure of the tie-rod, the response still was highest, 1.81 to 8.36 times stiffer than the edge panels depending on support conditions. Panels with the larger content of fibres (80 kg/m³) showed only one significant crack at the top side and had shorter and thinner cracking in both top and bottom sides of slab than the panels with the smaller fibre content (40 kg/m³). In the panels with the larger content the crack widths at the top was about 20-60 % of the crack widths at bottom while for the smaller content the same relation is 50-200 %, hence, the significant cracks were larger and more frequent in a less strain hardening fibre concrete.

In **Paper D**, *Long term Full Scale Test of a Pile Supported Steel Fibre Concrete Slab*, the research on long-term properties of structural SFC was conducted on a flat slab supported by concrete columns. The slab had previously been subjected to loadings in several positions (see **Paper C**). The flat slab is subdivided in two main parts with different fibre content. In transverse direction to these two parts the slab was additionally equipped with reinforcement bars.

The slab was subjected to heavy sustained loading during 12 months. The loads were obtained by 1000-1200 kg weights that were magnified to 5000-7500kg through a lever arm. A total of 8 weights were applied at 8 symmetrically placed points under the slab.

In this paper a method to calculate the long-term deformation is proposed. The method gave satisfactory correspondence between measured long-term deflections and computed ones if the creep ratio was calculated based on temperature and relative humidity for the area. Values on temperatures measured in the real building concrete varied too much to be used in evaluation. The substantial part of the research work on long-term studies on SFC pile supported slabs are presented in **Paper D**, submitted to ACI - Concrete Journal, and has not yet been presented at any conference. Parts of the results are presented at an internal competence development conference for structural design engineers at Tyréns held the 7th September 2012 in Gothenburg, Sweden.

Chapter 5

Conclusions and suggestions for further work

5.1. Conclusions

Important findings in the full-scale testing

The use of a moderate fibre content of nominal 40 kg/m^3 did end up in a larger number of visible cracks than the nominal fibre content of 80 kg/m^3 . In reality the fibre contents were $31.5 - 33.8 \text{ kg/m}^3$ and $60.6 - 91.3 \text{ kg/m}^3$, respectively. The visible cracking of the concrete surface decreased as the fibre content increased.

The performed full-scale testing proves that fibre reinforced concrete, to a significant load to span/depth ratio, actually managed to bear the loadings without sudden burst in collapse.

Also the load bearing capacity was preserved, even after loading to near failure or where the slab was expected to “turn-over” at maximum of arch action (at the large deflection equalling the slab thickness).

The arch action seemed to be present at all tested loading situation with support from the surrounding slab.

However as the practical experience grow in Sweden and internationally and additional full scale test programs are completed more secure estimations will be present.

The short-term tests showed that SFC may resist substantial loading, far more than could be calculated.

And of importance - it does not fall down in the head of people standing beneath.

In case of pile supported floors where the ground may be less than half the slab thickness from the underside of the slab – it does not break down under your feet, if the load should be kept in levels so that the deformations is less than half the thickness of the floor slab. This deformation will of course be a serviceability issue, most end user will not be satisfied with. However when designing with the developed method for creep deformation the slab probably

will end up at deformation levels that are in compliance with the requirements stated in most design codes and the users' sometimes even tougher demands.

In long-term, if you have got a space underneath, this could be possible. This kind of settlements frequently occurs (the maximum space measured after long-term dehydration of ground is 1.4 m, measured in project No. 19, Strängnäs, **Paper B**).

Present threats using SFC in real designs

As mentioned earlier there are some difficulties in construction with present types of steel fibres at high fibre contents. Examples are pumping, fibre balling and dispersion. When building structures with SFC as material these problems often are believed to be important to be eliminated and must be solved. There are also issues regarding the norms and codes and standard works that must be filled out with theories and with practical experience.

Neither Swedish nor European official design codes do yet cover steel fibres as the only reinforcement in structural applications. Despite the fact that no official design code has dealt with the design with SFC, steel fibre concrete is frequently used in structural applications all over the Europe and has been used in other places of the world in similar situations.

As the design solutions, used for steel fibre only and combined reinforcement only have been verified in rather limited test situations (laboratory tests of small beams and slabs are common) and often only in ultimate limit state or fatigue – many people involved are afraid that the consequences of structural damages or excessive displacements and cracking is a pending and potential risk that will occur if using SFC.

The experience of testing is evidently significant in some areas such as short term flexure and strain but less apparent in other areas such as short term shear and long term creep.

The difference in how to see design with SFC between companies and sometimes between more scientific institutions is immense; however the larger scientific group is more gathered. And now many designers and contractors are waiting for the coming design standard, of course due to concerns and experiences from the above problems – the standard may not be too far away.

However as stated in the committee report of ACI 360R-10 (2010) “Even with the best slab designs and proper construction, it is unrealistic to expect crack--free and curl-free floors. Every owner should be advised by the designer and contractor that it is normal to expect some cracking and curling on every project. This does not necessarily reflect adversely on the adequacy of the floor's design or quality of construction.”

The statement by the American committee is not all true – fortunately. But of course this gives the designer and contractors a defuse task to solve and for SFC this is a problem often related to strain or bending softening SFC. SFC industrial pile supported floor slabs are in fact a solution that is redundant (as proven in **Paper C** and **Paper D**), less hazardous and is possible to design with the methods given in SCA report No. 13 and the proposed methodology for integrated design and construction of industrial floors given in Hedebratt (2004). Also there are in fact a number of solutions to overcome the mentioned problems. (a) Design well, (b) select the appropriate materials and (c) construct well – is not just empty

5.2. EARLIER SUGGESTIONS FOR FURTHER WORK

rhetoric. As example of a detailing problem the always curling corners and jointed edges, here the slab never get the right reinforcement to manage the bending moments from the restraining other half and the external loadings, also wrongly assembled joints produce similar damage. Two simple tasks to design and execute correctly that would have reduced the occurring cracks in project No. 1 – No. 25 (see **Paper B**). However in this issue the current designer could not convince the contractor. A simpler but thereafter frequently used solution was putting reinforcement bars in fan-shape, unfortunately not enough for all floors. The communication between client – contractor – material suppliers – and designers is of immense importance. And utterly the treat lies in what is communicated and what value it brings.

5.2. Earlier suggestions for further work

The SCA report No. 4 (1997) gave examples on important subjects for future research, both for the material SFC and for SFC structures. The examples are e.g. fatigue, durability (corrosion resistance), and production issues e.g. mixing of moderate to high content of fibres to the concrete and rheology, crack distribution for restrained shrinkage and temperature movements, restraint stresses and crack risk and crack patterns, behaviour at combined external and restraining loading, limit analysis on SFC structures and rotation capacity, moment and shear capacity and behaviour of combined reinforced structures i.e. combinations of (i) micro fibres and macro fibres, (ii) bar reinforcement and steel fibres, and (iii) pre-tension and steel fibres. Behaviour and bearing capacity of elevated flat slabs that is locally steel fibre reinforced. And strengthening of concrete structures through toppings or sprayed concrete.

All of these suggestions, almost (spraying SFC will probably not be a success for floors), are question marks that are needed to be solved in order to perform well in design and construction of pile supported SFC slabs.

Now in 2012, 15 years later, the research work by the author of this thesis has stepped into many of the suggested research areas, and also other researcher on SFC has covered many of them. Also the suggested research in the now 5 year old SCA report No. 13 (2008) has begun and are in part now concluded with this thesis. Although to completely cover them still there is much work to carry out. You could recognise that the researches on SFC are now more widely spread in the world than they were 15 years ago. Modern communication e.g. the Internet makes it easy to share the knowledge. The possibility to analyse material and structural behaviour by computer; e.g. Inverse analysis and Finite Element Modelling (FEM) and also Building Information Modelling (BIM) in several dimensions have had an enormous growth the last decade. Therefore the research on SFC will accelerate even more and new applications for SFC will be further discovered. The current most important is the actual utilisation of the discoveries from present and to future construction.

5.3. Suggestions for further work

Several questions and ideas arise during the project. As the work proceeded the ideas were sorted out and became more mature, not always as bright as when they appeared and

sometimes as a vague feeling. Some ideas that the author has had a more profound feeling for and that ought to be investigated further are briefly presented.

Arch - and membrane actions from surrounding concrete slab

In the full-scale tests the arch action at point loading at high deformation levels was obvious without any external lateral support at edges of the elevated slab. The arch actions seem to be from the surrounding SFC slab itself. In pile supported slabs this action may be significant also, even at low deformations levels. As the slabs expand laterally the deformation surface rotate through its zero inflection line, and this result in arch action and also membrane action.

Arch action and membrane action may develop in concrete slabs if the expansion and shortening, respectively, in the horizontal direction are restrained. If the ratio h/L between slab thickness and slab length has a certain magnitude (often the case in practice), both actions may develop also at small deflection levels. The arch develops inside the slab between the bottom side of the slab at the periphery and the top side of the slab at slab centre. The membrane will have the opposite shape (from top to bottom). The necessary restraint will be caused by friction to the subgrade, adjacent slab parts, surrounding walls or surrounding edge beams. The significance of these actions for pile-supported floors should be investigated.

Punching shear of point loaded SFC slabs

Full-scale testing of punching shear in elevated SFC slabs has not been performed earlier as such. This kind of loading is seldom designing in levels of loads in the building code requirement. In industrial building however the requirements on the load levels often are significant. In pile supported slabs and especially when having high racking or large distributed loads punching shear may occur and is often designing the dimensions .i.e. the slab is rather designed for the piling rather than the loading. When loading with point loads in-between the pile grid punching is currently seldom checked. In the present full-scale test punching may have been the actual final failure mode in two occasions, even if the deformation levels were at the limit of turn-over of the arch compressive resultant in all cases.

Creep deformation in constant versus fluctuating climate and loading conditions

In-house climate as often is the case in industrial building has often rather constant temperature and humidity conditions. The creep of concrete is easy to apply when calculating flexural deformations, for SFC this seems also to be true. When the on deformation influencing parameters are fluctuant, as often is the case for out-door conditions, advises on how to perform the design calculation may mislead and be approximated. SFC has shown to have a small creep behaviour compared to reinforced concrete (NC) and is therefore a promising material to use in creep sensitive structures. The calculation methods for creep deformation for these applications need to be up-dated for NC and also complemented in new standards for SFC.

The flexural bending and deformation capacities of true strain hardening SFC

Although the strain softening concrete managed well in the load test, both in short and long terms, the more strain hardening the SFC were the less was the appearing cracks. A true strain

hardening SFC is expected to be even more advantageous regarding flexural bending and deformation properties and also for crack control.

The flexural bending and deformation behaviour of SFC slabs with large holes

Often large holes in the pile supported slabs (in elevated flat slabs as well) are formed or cut afterwards. This is due to elevator shafts or for other installations as ventilation ducts or piping or even chimneys. This is often solved with extra reinforcement of stirrups or edge beams in actual production. With strain hardening concrete this may be solved without any further action, but in a more economical way if it could be verified through test and analysis.

The flexural bending and deformation capacities of SFC slabs at UDL in long-term

In this thesis a full-scale test is concluded in **Paper C** and **Paper D**, where the loadings were from point loadings in short- and long-term. It has not been found any research where the long-term service loading comprises distributed loads for pile-supported SFC floor slabs. In all present studied cases the loading time was relatively short and thus not covering the expected life-time of the slab.

Bibliography

Altoubat, S.A. and Lange, D.A. (2003). "A new look at tensile creep of fiber reinforced concrete", ACI Special Publication on Fiber Reinforced Concrete, ed. N. Banthia, 2003.

ACI 318-08, (2008). "Building Code Requirements for Structural Concrete (ACI 318-08) and commentary, American Concrete Institute, Farmington Hills", MI, 473 pp.

ACI Committee 544 (1988). "Design Considerations for Steel Fibre Reinforced Concrete". American Concrete Institute, Farmington Hills, MI. ACI Journal, 1988 (V85), no. 5, pp. 563-580.

ACI Committee 544, (1996). "Report on Fiber Reinforced Concrete" (ACI 544.1R-96) (Reapproved 2009), American Concrete Institute, Farmington Hills, MI, 66 pp.

ACI 360R-10 (2010). "Guide to Design of Slabs-on-Ground", American Concrete Institute, Farmington Hills, MI, September 2010, 72 pp.

Andersson, J. (1964). "Punching of concrete slabs: Slabs with shear reinforcement and reinforced or post-tensioned lift slabs: Summary slabs with shear reinforcement and reinforced or post-tensioned lift slabs", Doctoral thesis, Royal Institute of Technology, thesis no. 190, Stockholm, 1964, 8 pp.

Andersson, J. (1963). "Punching of concrete slabs with shear reinforcement", Transactions of the Royal Institute of Technology Report no. 212, Stockholm, 1963, 59 pp. (In German)

ASTM A820 / A820M (2011). "Standard Specification for Steel Fibers for Fiber-Reinforced Concrete". ASTM International, West Conshohocken, PA, 1997, DOI: 10.1520/A0820_A0820M-11, www.astm.org, 4 pp.

ARMY TM 5-809-12 (1987), "Concrete Floor Slabs on Grade Subjected to Heavy Loads". Air Force Manual No. 88-3, Chapter 15, Headquarters Departments Of The Army And The Air Force Washington, D.C., USA, 25th August, 1987, 57 pp.

ASTM Standard C1018-97 (1997). "Standard Test Method for Flexural Toughness and First-Crack Strength of Fiber-Reinforced Concrete (Using Beam With Third-Point Loading)". ASTM International, West Conshohocken, PA, 1997, DOI: 10.1520/C1018-97, www.astm.org, 7pp.

ASTM C1116 / C1116M (2010). "Standard Specification for Fiber-Reinforced Concrete". ASTM International, West Conshohocken, PA, 1997, DOI: 10.1520/C1116_C1116M-10A, www.astm.org, 7 pp.

ASTM Standard C1550-10 (2010). "Standard Test Method for Flexural Toughness of Fiber Reinforced Concrete (Using Centrally Loaded Round Panel)". ASTM International, West Conshohocken, PA, 2010, DOI: 10.1520/C1550-12, www.astm.org, 14 pp.

ASTM Standard C1609/ C1609M (2010). "Standard Test Method for Flexural Performance of Fiber-Reinforced Concrete (Using Beam With Third-Point Loading)". ASTM International, West Conshohocken, PA, 2010, DOI: 10.1520/C1609_C1609M-10, www.astm.org, 9 pp.

BIBLIOGRAPHY

Ashour, S.A., Hasanain, G.S., Wafa, F.F. (1992). "Shear behaviour of High-Strength Fiber Reinforced Concrete Beam". *ACI Journal*, (V89), No. 2, 1st March, 1992, pp 176-184.

Ay, L. (2004). "Steel Fibrous Cement based Composites. Part one: Material and mechanical properties, Part two: Behavior in the anchorage zone of prestressed bridges". TRITA-BKN. Bulletin 75, ISSN 1103-4270. Department of Civil and Architectural Engineering, Division of Structural Design and Bridges, Royal Institute of Technology, 266 pp.

BBK 04. (2004) "Boverkets handbok om betongkonstruktioner" ("Handbook on Concrete Structures"). Swedish National Board of Housing, Building and Planning, Karlskrona, Sweden, 271 pp. (In Swedish).

Banthia, N. (1998). "Fiber reinforced concrete: Present and the future, Fiber reinforced concrete". Edited by Banthia, N., Bentur, A. and Mufti. A, Canadian Society for Civil Engineering, 271 pp.

Bazant, Z.P. and Panula, L. (1978). "Practical Prediction of Time-Dependent Deformation of Concrete," *Materials and Structures*, Part I and II: Vol. 11, No. 65, 1978, pp. 307-328; Parts III and IV: Vol. 11, No. 66, 1978, pp. 415-434; Parts V and VI: Vol. 12, No. 69, pp. 169-173.

Bazant, Z.P. and Chern, J.-C. (1985). "Triple Power Law for Concrete Creep," *Journal of Engineering Materials*, Vol. III, No. 4, pp. 63-83, (2003).

Bentur, A., et al. (1995). Bentur, A., Wu, S.T., Banthia, N., Baggott, R., Hansen, W., Katz, A., Leung, C.K.W., Li, V.C., Mobasher, B., Naaman, A.E., Robertson, R., Soroushian, P., Stang, H. and Taerwe, L.R., "Fibre-matrix Interfaces" in "High Performance Fiber Reinforced Cement Composites 2". A. E. Naaman and H. W. Reinhardt (editors), *Proc. Int. Rilem Conf., An Arbor, June 11 – 14, 1995*, (E & FN Spon, London, 1996), pp. 149-192.

Bentur, A. & Mindes, S. (2007). "Fibre Reinforced Cementitious Composites". Second Edition, (1990), 2007. 601 pp.

Bernard, E.S., & Pircher M., (2000). "Influence of geometry on performance of round determinate panels made with fibre reinforced concrete", engineering report No.: CE10, School of Civil Engineering and Environment, UWS Nepean, Kingswood NSW, Australia (January 200) ISSN 1326-0693.

Bernard, E.S. (2002). "Correlations in the behaviour of fibre reinforced shotcrete beam and panel specimens". *Materials and Structures*, Vol. 35, April, 2002, pp. 156-164.

Birke, H. (1975). "Kupoleffekt vid betongplattor" ("Arch effect in concrete slabs"), *Transactions of the Royal Institute of Technology Report no. 108*, Stockholm, 1975, 153 pp.

Carlsvärd, J. (2006). "Shrinkage cracking of steel fibre reinforced self compacting concrete overlays – Test methods and theoretical modelling". Doctoral thesis, Department of Civil and Mining Engineering, Division of Structural Engineering, Luleå tekniska universitet, Luleå, Sweden, 262 pp.

Chan, Y.W., and V.C. Li, (1997). "Effects of Transition Zone Densification on Fiber/Cement Bond Strength Improvement". *Journals of Advanced Cement Based Materials*, Vol. 5, No. 1, 1997, pp. 8-17.

Chan, Y.W. and Chu S.H., (2004). "Effect of silica fume on steel fiber bond characteristics in reactive powder concrete". *Cem. Concr. Res.* 34, 2004, pp. 1167-1172.

CNR (2006). "Guide for the Design and Construction of Fiber-Reinforced Concrete Structures", CNR DT 204/2006. Rome, Italy, November 2007.

Commission on Pile Research (2011), "Pålstatistik för Sverige 2010". ("Piling statistics for Sweden 2010"), Information 2011:1, Linköping, Maj 2011, 9 pp.

CUR 36 (2011). "Design of concrete floors and pavements on elastic foundations. (Ontwerpen van elastisch ondersteunde betonvloeren en -verhardingen)", The Netherlands, 23 pp.

CUR 111 (2007). "Steel fibre-reinforced Concrete Industrial Floors on Piles – Dimensional Analysis and Performance". Gouda, The Netherlands, December 2007, 28 pp.

DAfStb (2010). DAFStb guidelines: "DAfStb-Richtlinie Stahlfaserbeton". Deutscher Ausschuss für Stahlbeton - DAFStb, Berlin, Germany, März (March) 2010. (In German)

DBV-Merkblatt Faserbeton (2001) DBV "Steel Fibre Concrete", (Deutsche Beton Vereinung) Deutscher Beton- und Bautechnik-Verein E.V. (DBV), German Society for Concrete and Construction Technology, October 2001, 77 pp.

De Hanai, J.B., & Holanda, K.M.A. (2008). "Similarities between punching and shear strength of steel fiber reinforced concrete (SFRC) slabs and beam". *IBRACON Structures and Materials Journal*, ISSN 1983-4195, Volume 1, Number 1, (March, 2008), pp. 1 – 16.

Destrée, X. (2001). "Steel fibre reinforcement for suspended slabs". *Concrete*, September, 2001, pp. 58-59.

Destrée, X. (2004). "Concrete Free Suspended Slabs Reinforced With Only Fibres: Full-scale Testing Results and Conclusions –Design Examples". *FRC, BEFIB 2004, Sixth International Rilem Symposium*, 8 pp.

Destrée, X. & Mandl, J. (2008). "Steel fibre only reinforced concrete in free suspended elevated slabs: Case studies, design assisted by testing route, comparison to the latest SFRC standard documents", *Tailor Made Concrete Structures – Walraven & Stoelhorst (eds)*, © 2008 Taylor & Francis Group, London, ISBN 978-0-415-47535-8, pp. 437-443.

Dupont, D. & Vandewalle, L. (2004). "Comparison between the round plate test and the Rilem 3-point bending test". *6th RILEM Symposium on FRC-BEIFIB 2004, Varenna, Italy*, pp. 101-110.

DIN 1048 (1991), "*Testing concrete, part 1, Testing of fresh concrete: post-crack load capacity of fibre reinforced concrete*", DIN, Berlin, 1991. (In German)

BIBLIOGRAPHY

- Døssland, Å. L. (2008). "Fibre Reinforcement in Load Carrying Concrete Structures: Laboratory and Field Investigations compared with Theory and Finite Element Analysis", Doctoral thesis, monograph (Other scientific), ISBN 978-82-471-6910-0. Norwegian University of Science and Technology, Faculty of Natural Sciences and Technology, Department of Biology, 288 pp.
- Emborg, M. (1989). "Thermal stresses in concrete structures at early ages," Doctoral Thesis 1989:73, Division of Structural Engineering, Luleå University of Technology, Luleå, Sweden.
- Falkner, H. and Gossila, U. (1999). "Pile Supported Reinforced or Prestressed SFRC Ground Slabs". Institut für baustoffe, Massivbau und Brandschutz (iBMB), Technische Universität Braunschweig, Germany: PRO 6: 3rd International RILEM Workshop on High Performance Fiber Reinforced Cement Composites (HPFRCC 3) (51), 595 – 602 pp.
- Gossila, U. (2006). "Flachdecken aus Stahlfaserbeton (Elevated slabs of Steel Fibre Concrete)", "Beton- und Stahlbetonbau", Februari 2006, No. 2, Vol. 101, Germany, pp. 94-102. (In German)
- Groth, P. (1996). "Cracking in concrete: crack prevention with air-cooling and crack distribution with steel fibre reinforcement". Paper D: "Steel fibre reinforced concrete - tests and evaluations", part of Licentiate thesis. Department of Civil and Mining Engineering, Division of Structural Engineering, Luleå University of Technology, Maj 1996. 15 pp.
- Groth, P. (2000). "Fibre Reinforced Concrete - Fracture Mechanics Applied on Self-Compacting Concrete and Energetically Modified Binders", Doctoral Thesis 2000:4, ISSN: 1402-1544, Department of Civil and Mining Engineering, Division of Structural Engineering, Luleå University of Technology, January 2000, 237 pp.
- Gustafsson, J., Ohlsson, U. and Noghabai, K. (1999). "Steel Fiber Reinforced Concrete in Prestressed Beams". Report no 99:05, Division of Structural Engineering, Luleå University of Technology, Luleå, Sweden.
- Hallgren, M. (1994). "Flexural and Shear Capacity of Reinforced High Strength Concrete Beams without Stirrups". Licentiate thesis (summary), Bulletin 9, TRITA-BKN, Department of Structural Engineering, Royal Institute of Technology, Stockholm, 1994
- Hallgren, M. (1996). "Punching Shear Capacity of Reinforced High Strength Concrete Slabs". Doctoral thesis, Bulletin 23, TRITA-BKN, Department of Structural Engineering, Royal Institute of Technology, Stockholm, 1996, 206 pp.
- Hallgren M., Kinnunen S. and Nylander B. (1998). "Punching Shear Tests On Column Footings", Nordic concrete research, Stockholm, Sweden, 1998, 23 pp.
- Hassanzadeh, G. (1998). "Betongplattor på pelare - Förstärkningsmetoder och dimensioneringsmetoder för plattor med icke vidhäftande spännarmering (Concrete slabs on columns. Strengthening methods and design methods for slabs with non-bonding pre-tension reinforcement)". Licentiate thesis, Bulletin 43, TRITA-BKN, Department of Structural Engineering, Royal Institute of Technology, Stockholm, 1996, 160 pp.

- Hedebratt, J. (2000). "Steel fibre concrete in pre-tensioned concrete beams: study of the size effect on considering spalling forces in the anchoring zone on SFRC beams. (Stålfiberbetong i förespända betongbalkar: studie av storleksberoende i avseende på spjälkningskrafter i ändzonen på SFRC balkar)". Master Thesis, Depart. Of Civil and Mining Engineering / Structural Engineering, Luleå University of Technology, ISSN 1402-1617 / ISRN LTU-EX--00/107--SE / NR 2000:107, 2000. (In Swedish)
- Hedebratt, J. (2001). "Integrated design and construction of industrial floors – Demands on Industrial floors". TRITA-BKN. Report 64, Department of Structural Engineering, Royal Institute of Technology, Stockholm, 2001, 95 p. (In Swedish)
- Hedebratt, J. (2003b). "Integrated design and construction of industrial floors – Pilot study 1". Report 69, TRITA-BKN. Rapport 69, Department of Structural Engineering, Royal Institute of Technology, 2003, 79 p. (In Swedish).
- Hedebratt, J. (2004) "Integrated design and construction of industrial floors - Methods to Improve the Quality, Licentiate thesis, Bulletin No 78, Department of Structural Engineering and Bridges, Royal Institute of Technology, Stockholm, Sweden, 232 pp. (In Swedish.)
- Hillerborg, A. (1974). "Dimensionering av armerade betongplattor enligt strimlemetoden (Design of reinforced concrete slabs according to the strip method)", Stockholm, Aimqvist & Wiksell, 1974, 327 pp.
- Hillerborg, A. (1975). "Strip method design", Viewpoint, ;London, 1975, 256 pp.
- Hillerborg, A. (1976) Hillerborg A., Modéer M., and Petersson P-E. "Analysis of crack formation and crack growth in concrete by means of fracture mechanics and finite elements". Cement and Concrete Research. Vol. 6, pp 773-782.
- Holmgren, J. (1987). "Bergförstärkning med sprutbetong". Vattenfall Vattencraft, Vällingby. ISBN 91-77186-298-6, 1992. (In Swedish)
- Holmgren, B.J. (2000). "Punching research history at KTH. International Workshop on Punching Shear Capacity of RC Slabs", Stockholm , SUEDE (07/06/2000) 2000, vol. 57 (535 p.) (28 ref.), pp. 1-12.
- Ingerslev, A. (1921). "Om en elementær beregningsmetode af krydsarmerede plader (On a Simple Analysis of Two-Way Slabs)". Ingeniøren, 30, 69, 1921, pp 507-515.
- Ingerslev, A. (1923). "The Strength of Rectangular Slabs", Struct. Eng., 1, 1, 1923, pp 3-14.
- Jansson, R. (2008). "Material properties related to fire spalling of concrete", Licentiate Thesis, Division of Building Materials LTH, Lund University, 120 pp.
- JSCE-SF4 (1984). "JSCE-SF4 - Standard for Flexural Strength and Flexural Toughness - Method of Tests for Steel fiber Reinforced Concrete". Concrete Library of JSCE, No. 3, June 1984, Japan Concrete Institute (JCI), pp. 58-66.

BIBLIOGRAPHY

- Johansen, K.W. (1931). "Beregning af krydsarmerede jernbetonpladers brudmoment. Bygningsstatistiske Meddelelser", 3, 1, 1931, pp. 1-18 (German version: "Bruchmomente der Kreuzweise bewehrten Platten, Mem. Int. Ass. Bridge Struct. Eng., 1, 1932, pp 277-296.
- Johansen, K.W. (1943). "Brudlinieteorier". Technical University of Denmark, Technical University of Denmark, Denmark, 1943, 189 pp.
- Johanssen, K.W. (1962). "Yield-line theory". Cement and Concrete Association, London, 1962, 181 pp.
- Johansen, K.W. (1972). "Yield-Line Formulae for Slabs". Cement and Concrete Association, London, 1972, 106 pp.
- Johansson, L. (2003). "Lärdomar från 30 års golvutredningar". ("Lessons Learned from 30 Years of Concrete Floor Investigations"), Summaries of the Information Day, Swedish Cement and Concrete Research Institute, Stockholm, Sweden, pp. 11-14. (In Swedish).
- Kanstad, T. (NTNU), et al. (2011). "Forslag til retningslinjer for dimensjonering, utførelse og kontroll av fiberarmerte betongkonstruksjoner". ("Proposals for guidelines for design, execution and controll of fibre reinforced concrete structures"). SINTEF Building and Infrastructure, COIN Project report 29 (2011), (In Norwegian)
- Khanlou, A., & MacRae, G. A., & Scott, A. N., & Hicks, S. J., and Clifton, G. C. (2012). "Shear Performance of Steel Fibre-Reinforced Concrete". Proceedings of the Australian Structural Engineering Conference, Perth, Western Australia, 11th-13th July, 2012, no 51, 8 pp.
- Kaushik, et al. (1987). "Behaviour of Fibre Reinforced Concrete Beams in Shear". Proceedings of the international Symposium on Fibre Reinforced Concrete, Madras, India, 16th-19th December, 1987, vol. 1, pp. 133-149.
- Kinnunen, S. & Nylander, H. "Punching of concrete slabs without shear reinforcement". Stockholm, Transactions of the Royal Institute of Technology Report no. 158, 160 pp.
- Knapton, J. (2003). "Ground bearing concrete slabs – Specification, design, construction and behaviour". Thomas Telford Publishing, London, Great Britain, 299 pp.
- Kooiman, A.G., van der Veen, C. and Walraven J.C. (2000). "Modelling the post-cracking behaviour of steel fibre reinforced concrete for structural design purposes". Heron, Vol. 45, No.4 (2000), ISSN 0046-7316, pp. 275-307.
- Kullaa, J. (1997), "Finite element modelling of fibre-reinforced brittle materials". Heron, Vol. 42, No.1 (1997) ISSN 0046-7316, pp. 75-93.
- Lambrechts, A. N. (2012). "R&D Project", Presented at Bekaert Launches of the New and Ultimate Dramix® range, Bekaert, Belgium, 10th-11th September 2012.
- Losberg, A. (1960). "Structurally Reinforced Concrete Pavements". Doctoral Thesis, Chalmers tekniska högskola, 1960, Göteborg, Sweden, 444 pp. (In Swedish)

- Löfgren, I. (2005). "Fiber-reinforced Concrete for Industrial Construction – A Fracture Mechanics Approach to Material Testing and Structural Analysis". Ph.d. Thesis Institutionen för bygg- & miljöteknik, Chalmers tekniska högskola, Göteborg, 268 pp.
- Maya, L.F., & Fernández Ruiz, M., & Muttoni, A., Foster, S.J. (2012). "Punching shear strength of steel fibre reinforced concrete slabs". *Engineering Structures*, vol. 40, 2012, pp. 83–94.
- Meda, A., & Plizzari, G.A. (2004). "New Design Approach for Steel Fiber-Reinforced Concrete – Slabs-on-Ground Based on Fracture Mechanics". *ACI Structural Journal*, Title no. 101-S30, Vol. 101, No. 3, May-June 2004, 6 pp.
- Mobasher, B., & Soranakom, C., & Destrée, X. (2007). "Elevated Slabs with Steel Fibre Reinforced Concrete: Full scale testing, and Inverse Analysis of FRC Round Panel Tests", *ACI Fall Convention 2007*, 10 pp.
- Morgan, D.R., Mindess S., Chen, L. (1995). "Testing and specifying toughness for fibre reinforced concrete and shotcrete". *Proceedings of the Second University-Industry Workshop on Fiber Reinforced Concrete and Other Advanced Composite*, Univ. of British Columbia, Canada, 1995, pp. 29-50.
- Molins, C., Aguado, A., Marí, A.R. (2006). "Quality Control Test for SFRC to be Used in Precast Segments". *Dept. of Construction Engineering, Technical University of Catalonia, (Spain), Tunnelling and Underground Space Technology 21 (3-4), Special Issue: Safety in Underground Space, Proceedings of the ITA-AITES 2006 World Tunnel Congress, Seoul, Korea, 2006*, 6 pp.
- Murty, D.S.R. & Venkatacharyula, T. (1987). "Fibre Reinforced Concrete Beam Subjected to Shear Force". *Proceedings of the international Symposium on Fibre Reinforced Concrete, Madras, India, 16th-19th December, 1987*, vol. 1, pp. 125-132.
- Naaman, A.E. (1985). "Fibre Reinforcement for Concretes". *Concrete International: Design and Construction*. 7(3), pp. 21-25.
- Naaman, A.E. (1998). "New fiber technology: Cement, ceramic and polymeric composites". *Concrete International*, 20 (7), pp. 57-62.
- Naaman, A.E. (1999). "Fibers with slip-hardening bond". Presented in *High Performance Fiber Reinforced Cement Composites – HPRCC 3*. H.W. Reinhart and A.E. Naaman, Eds., Pro 6, RILEM Publications, S.A.R.L., pp 371-385.
- Naaman, A.E. (2000). "Fibre Reinforcement for Concretes: Locking back, looking ahead". Presented in: *Proceedings of Fifth RILEM Symposium on Fiber Reinforced Concretes (FRC)*, P. Rossi and G. Chanvillard, Ed., RILEM Publications, S.A.R.L., pp 65-86.
- Naaman, A.E. (2003). "Engineered Steel Fibers with Optimal Properties for Reinforcement of Cement Composites". *Journal of Advanced Concrete Technology*, Vol. 1, no. 3, November 2003, pp 242-252.

BIBLIOGRAPHY

- Naaman, A.E. (2007). "High Performance Fiber Reinforced Cement Composites: Classification and Applications", CBM-CI International Workshop, Karachi, Pakistan, 2007, 13 pp.
- Narayanan, R. & Darwish, I.Y.S. (1987). "Shear in Prestressed Concrete Beams Containing Steel Fibres". *The International Journal of Cement Composites and Lightweight Concrete*, Volume 9, no. 2, pp.81-90.
- NBN B 15-238 (1992). "Essais des bétons renforcés de fibres – Essai de flexion sur éprouvettes prismatiques". NBN Bureau de normalisation, Norm Belge, 1992, 8 pp.
- NBN B 15-239 (1992). "Caractérisation d'une fibre d'acier au départ de la résistance conventionnelle à la flexion". NBN Bureau de normalisation, Norm Belge, 1992, 7 pp.
- NF P 18-409 (1993). "Béton avec fibres métalliques - Essai de Flexion". Normalisation française, AFNOR, France; 1993. 8 pp.
- Nilsson, U. (2003). "Structural behaviour of fibre reinforced sprayed concrete anchored in rock". Doctoral Thesis, TRITA-BKN. Bulletin 71, ISSN 1103-4270, ISRN KTH/BKN/B--71—SE, Royal Institute of Technology, Dep. of Structural Engineering, Stockholm, 2003. 250 pp.
- Noghabai, K. (1998). "Effect of Tension Softening on the Performance of Concrete Structures – Experimental, Analytical and Computational Studies". Doctoral Thesis 1998:21, Department of Civil and Mining Engineering, Division of Structural Engineering, Luleå, Sweden, 166 pp.
- Nordström, E. (2005). "Durability of sprayed concrete: steel fibre corrosion in cracks", Doctoral thesis, Civil and Environmental Engineering / Structural Engineering, Luleå University of Technology, 171 pp.
- Ošlejs, J. (2008). "New Frontiers for Steel Fiber - Reinforced Concrete - Experience from the Baltics and Scandinavia", *Concrete International*, May 2008, pp.45-50.
- Parmentier, B. & De Grove, E. & Vanderwalle, L. & Van Rickstal, F. (2008). "Dispersion of the mechanical properties of FRC investigated by differens bending tests". *Proceedings of tailor Made Concrete Structures New Solutions for Our Society*. Walraven & Stoelhorst (eds). (FIB 2008), May, Amsterdam, The Netherlands, pp. 507-512.
- Rasmussen, T.V. (1997). "Time dependent interfacial parameters in cementitious composite materials". Ph.D. thesis, Series R No. 33, Dep. of Structural Engineering and Materials, Technical University of Denmark, Lyngby. Denmark, 170 pp.
- RILEM TC 162-TDF (2001). "Test and design methods for steel fibre reinforced concrete - Recommendations for uni-axial tension test". *Materials and Structures*, vol. 34, pp. 3-6
- RILEM TC 162-TDF (2002). "Test and design methods for steel fibre reinforced concrete - Bending test". *Materials and Structures*, vol. 35, pp. 579-582.

- RILEM TC 162-TDF (2003). "Test and design method for steel fibre reinforced concrete – Sigma-epsilon-design method". *Materials and Structures*, vol. 36, no. 262, pp. 560-567.
- Salomonsson, H. (2002). "Design of self-compacting steel fibre concrete structures (Dimensionering av självkompakterande stålfiberbetongkonstruktioner)". Master Thesis 184, Structural Engineering, Royal Institute of Technology, Stockholm, Sweden. (In Swedish)
- Saluja et al. (1992). "Flexural and Shear Strength of Fibre Reinforced Concrete Beams". *Journal of Structural Engineering (India)*, 1992 (V19), no. 3, pp. 101-105.
- Sandbaak, S. (2011). "Fibre Reinforced Concrete – Evaluation of test methods and material development". Doctoral thesis, Norwegian University of Science and Technology, NTNU, 186 pp.
- Schumacher, P., Walraven, J. C., den Uijl, J. A. (2009). "Rotation capacity of self-compacting steel fibre reinforced concrete beams". *Heron Vol. 54, No.2/3, 2009*, pp. 127-161.
- Shin, S.W., et al. (1994). "Shear Strenght of Steel Fiber Reinforced Concrete Beams". *ACI Journal*, 1986 (V83), no. 4, pp. 624-628.
- Singh, Z. A., et al. (2010). "Drying Shrinkage Characteristics of Concrete Reinforced With Oil Palm Trunk Fiber", *International Journal of Engineering Science and Technology*, Vol. 2(5), 2010, pp. 1441-1450.
- Skarendahl, Å. (1975). "Fiberbetong: produktionsmetoder, egenskaper och användning". ("Fibre concrete: methods for manufacturing, properties and application"), Stockholm: Swedish Cement and Concrete Research Institute. CBI Report no. 14:75, 16 pp. (In Swedish.)
- Skarendahl, Å. & Westerberg, B. (1989). "Handledning för dimensionering av fiberbetonggolv". ("Guidelines for design of fibre concrete floors"). Stockholm: Swedish Cement and Concrete Research Institute. CBI Report no. 1:89, 61 pp. (In Swedish.)
- SIA 162/6 (1999). "Stalfaserbetong", *Empfehlung SIA 162/6*, Schweizerischer Ingenieur- und Architekten-Verein, Zürich, 1999, 20 pp.
- Silfwerbrand, J. (1995). "Concrete Infrastructures", Handouts. Royal Institute of Technology, Dept. of Structural Engineering, Stockholm, 1995.
- Silfwerbrand, J. & Hassanzadeh, G. (2000). "International Workshop on Punching Shear Capacity of RC Slabs": proceedings: dedicated to Professor Sven Kinnunen, Royal Institute of Technology, TRITA-BKN, Bulletin 57, Dept. of Structural Engineering, Stockholm, Sweden, 7th-9th June, 2000, 572 pp.
- Silfwerbrand, J. & Hedebratt, J. (2013). "Industrial concrete floors - Recommendations and worked out examples on design". (draft, preliminary title) (*Industrigolv - Rekommendationer och utarbetade exempel för dimensionering*), Swedish Cement and Concrete Research Institute, Stockholm, 2013. (In Swedish)
- Stang, H., & Olesen, J.F., & Hansen, J. De Place (2001). Brite-Euram Project (2001). "Test and Design methods for Steel Fibre Reinforced Concrete", BPR-CT 98-0813, 2001.

BIBLIOGRAPHY

Sundquist, H., & Hassanzadeh, G., (2001). "The Influence of Steel Fibre Reinforcement on Punching Shear Capacity of Column Supported Flat Slabs". Proceedings of NCR Workshop on The Design of Steel Fibre Reinforced Concrete Structures, Stockholm, June 12, 2001.

Swamy, R.N. & Bahia, H.M. (1985). "The Effectiveness of Steel Fibers as Shear Reinforcement". Concrete International, 1985, (V7): No. 3, pp. 35-40.

SCA (1997). Swedish Concrete Society (SCA), "Concrete reports No. 4": "Steel fibre concrete – recommendations for design, execution and testing", edition 2, Swedish Concrete Society, Stockholm, 1997, 135 pp. (In Swedish)

SCA (2008). Swedish Concrete Association (SCA). "Concrete reports No. 13": "Industrial floors – recommendations for design, material selection, execution, operation and maintenance", edition 1, Stockholm, 2008, 296 pp. (In Swedish)

SCA (2011). Swedish Concrete Society (SCA). "Concrete reports No. 16": "Recommendation for prevention of fire spalling in concrete constructions". ("Rekommendationer för att förhindra brandspjälkning i anläggningskonstruktioner"), Swedish Concrete Society, Stockholm, 62 pp. (In Swedish)

SS-EN 14650 (2005). "Precast concrete products – General rules for factory production control of metallic fibre concrete", 8 pp.

SS-EN 14651 (2005). "Test method for metallic fibre concrete – Measuring the flexural tensile strength (limit of proportionality (LOP), residual)", 19 pp.

SS-EN 14721 (2005). "Test method for metallic fibre concrete – Measuring the fibre content in fresh and hardened concrete", 9 pp.

SS-EN 14845 (2007). "Test methods for fibres for concrete – Part 1: Reference concrete", 7 pp.

SS-EN 14845 (2006). "Test methods for fibres for concrete – Part 2: Effect on concrete", 7 pp.

SS-EN 1992-1-1 (2005). "Eurokod 2": "Dimensionering av betongkonstruktioner – Del 1-1: Allmänna regler för byggnader". ("Eurocode 2": "Design of concrete structures - Part 1-1: General rules and rules for buildings"). Swedish Standard, Stockholm: SIS Förlag AB, 2005.

SCB (2011). Statistics Sweden (SCB). "Year book 2011 - Housing and construction". ("Årsbok 2011 - Boende, byggande och bebyggelse"), Official Statistics of Sweden, 730 pp. (In Swedish)

The Swedish Buildings Manual (1972). "BYGG - Handbok för hus-, väg-, och vattenbyggnad - Allmänna grunder", Huvuddel 1B, Stockholm, 1972.

The Concrete Manual (1997). "The Concrete Manual – Execution". ("Betonghandbok – Arbetsutförande"), chapter 6.5, edition 2, 1997, 837 pp.

The Concrete Manual (1997). "The Concrete Manual – Material". Material (Betonghandbok – Material). chapter 29, edition 2, 1997, 1127 pp.

The Concrete Manual (1997). "The Concrete Manual – Design". ("Betonghandbok – Konstruktion", edition 2, 1997, 791 pp.

Thooft, H., Volker, H., Teutsch, M., Gossla. U., (2001)**. "Combination Reinforcement for Floor on Piles", Inventors: (**), assignee: N.V.Bekaert S.A., U.S. Patent 6,269,602 B1, date of patent *7th Aug 2001 (*notice: this patent is subject to a terminal disclaimer), United States Patent, 11 pp.

Thorenfeldt, E., Fjeld, S. et.al. (2006). "Stålfiberarmering i betong. Veiledning for prosjektering, utførelse og kontroll". (Steel fibre reinforcement in concrete. Guide for design, execution and control). Draft, 2006. (In Norwegian).

Tissink, A. (2010a). "Staalvezels sterke wapening – Geslaagde proef met woningbouwcasco in Eindhoven", ("Steel fibre strong reinforcement – Successful test of airframe housing in Eindhoven"). Cobouw 19th-21th June, No. 115, 2010, (The Netherlands). pp 1. (In Dutch)

Tissink, A. (2010b). "Staalvezel-beton waarschuwt keurig – Beton van de toekomst bezwijkt niet met broose breuk". ("Steel fibre concrete warns neatly – Concrete of the future does not succumb to brittle fracture"), Cobouw 22th June, No. 116, 2010, (The Netherlands). pp 11. (In Dutch)

Tjiptobroto, P. & Hansen, W. (1991). "Mechanism for Tensile Strain Hardening in High Performance Cement-based Fiber Reinforced Composites". Cement & Concrete Composites, vol. 13 (1991), pp. 265-273

Tolf, P. (1992). "Effect of slab thickness on punching shear strength". Licentiate thesis (summary), Transactions of the Royal Institute of Technology, report no. 160, Stockholm, 1992, 7 pp.

TR 34 (2003). "Concrete industrial ground floors - a guide to their design and construction". 3rd edition (includes amendment No. 1 to 4, Oct 04, Jan 05, Nov 05 and Feb 09), Concrete Society, Crowthorne, UK, 2003, 148 pp.

TR 63 (2007). "Guidance for the Design of Steel-Fibre-Reinforced concrete". Technical Report 63, The Concrete Society, Camberley, April 2007, 92 pp.

Täljsten, B. (1994). "Plate Bonding - Strengthening of Existing Concrete Structures with Epoxy Bonded Plates of Steel or Fibre Reinforced Plastics". PhD thesis, Luleå University of Technology.

UNI 11037 (2003). "Fibre di acciaio da impiegare nel confezionamento di conglomerato cementizio rinforzato" ("Steel Fibre To Be Used In The Preparation Of Reinforced Concrete Conglomerate"). UNICEMENTO, UNICEMENTO, The Authority for Standardization of Hydraulic Binders, Mortars, Concrete and Reinforced Concrete, February 2003, 14 pp.

BIBLIOGRAPHY

- UNI 11039-1 (2003) “Calcestruzzo rinforzato con fibre di acciaio - Definizioni, classificazione e designazione “, (“Steel fibre reinforced concrete - Definitions, classification and designation”). UNICEMENTO, The Authority for Standardization of Hydraulic Binders, Mortars, Concrete and Reinforced Concrete, February 2003, 7 pp.
- UNI 11039-2 (2003). “Calcestruzzo rinforzato con fibre di acciaio - Metodo di prova per la determinazione della resistenza di prima fessurazione e degli indici di duttilità”. (“Steel fibre reinforced concrete - Test method for determination of first crack strength and ductility indexes”). UNICEMENTO , February 2003, 11 pp.
- UNI 11188, 2004: “Design, Production and Control of Steel Fiber Reinforced Structural Elements”.
- UNI 11188, 2007: Steel Fibres Reinforced Concrete Structural Elements - Design, Execution And Control. 28 Mars 2007, 44 pp.
- Vitt, G. (2012), “Large scale tests”. Presented at Bekaert Launches of the new and ultimate Dramix® range, Bekaert, Belgium, 10th - 11th September 2012.
- Westergaard, H.M., Slater, W.A. (1921). “Moments and stresses in slabs”. Proceedings of the American Concrete Institute, Vol. 17, No. 2, pp. 415-538.
- Westergaard, H.M. (1922). “Buckling of elastic structures. Transacion of American Society of Civil Engineers”, Vl. 85, pp. 576-634.
- Westergaard, H.M. (1923). “Om Beregning af Plader paa Elastiskt Underlag med Sælight Henblik paa Spørsmålet Om Spændinger i Betongveje” (“On the Design of Slabs on Elastic Foundation with Special Reference to Stresses in Concrete Pavements”). Ingeniøren, Vol. 32, 1923, Copenhagen, pp 513-524.
- Westergaard, H.M. (1925). “Anwendung der Statik auf die Ausgleichsrechnung”. Dissertation, Munich TH.
- Westergaard, H.M. (1952). “Theory of Elasticity and Plasticity”. Harvard University Press, Cambridge, Mass., 1952.
- Westin, et al. (1992). Westin, I., Petersson, Ö., and Nordin, A.. “Stålfiberarmerade industrigolv”. (Steel fibre reinforced industrial concrete floors”). CBI Report no 6:92, 1992, 55 pp. (In Swedish)
- Westin, et al. (1992). Westin, I., Petersson, Ö. & Nordin, A.. “Stålfiberarmerade betonggolv”.(Steel fibre reinforced concrete floors). Stockholm, Cement och Betong Institutet, 1994. Uppdragsrapport nr 94015, 49 pp. (In Swedish)
- Wiberg, A. (2003). “Strengthening of Concrete Beams Using Cementitious Carbon Fibre Composites”, Doctoral Thesis, TRITA-BKN. Bulletin 72, ISSN 1103-4270, Concrete Structures, Royal Institute of Technology, 153 pp.

Wongtanakitcharoen, T. and Naaman, A.E. (2004). "Early age bon strength development of fibres in FRC composites". Sixth RILEM Symposium on Fibre-Reinforced Concrete (FRC) – BEFIB 2004, Rilem, pp. 431-442.

Published on the Internet

Incite, (2012). "Fibre Dosing - Fully Automatic Equipment For Steel and Synthetic Fibres", brochure, Incite AB, Simlångsdalen, Sweden, <http://www.incite.se>, 8 pp.

Glans,et.al.(2009).

"<http://www.jagvillhabostad.nu/text/2009/10/rekordlagt-bostadsbyggande-i-sverige>", published the 15th October 2009, 1 pp.

SCB (2010), Statistiska Centralbyrån, (Statistics Sweden), website, 2010-08-05. (In Swedish)

Commission on Pile Research (<http://www.palkommissionen.org/>)

Part II

APPENDED PAPERS

Paper A - Damages in Industrial Concrete Floors

Paper B - Lessons Learned-Swedish Design and Construction of Industrial Concrete Floors

Paper C - Full Scale Test of a Pile Supported Steel Fibre Concrete Slab

Paper D - Time-Dependent Deflection of
Pile-Supported Steel Fibre Concrete Slabs - Full-
Scale Test

Part III

**APPENDED TEST RESULTS, CALCULATIONS
AND PICTURES**

Appendix A

Summary of appended testing

Results from: Cylinder compression tests – drilled slab cores - tested at CBI

Cores were drilled-out from the tested slab in order to determine compressive strength and fibre content. The cores were taken at numbered positions in drawing TP 1:100.

After the test results provided by CBI three graphs are presented by the author. The graphs illustrate the distribution of fibres to density, compressive strength to density, distribution of fibres to density. The author also provides statistical treatment of the tests.

Results from: SCA No. 4 beam test - beam bending tests – tested at Bekaert

Prismatic beams were saw cut from the tested slab in order to determine bending strength, residual bending strength. The beams were taken at numbered positions in drawing TP 2:100.

Results from: SCA No. 4 beam test – cube compression tests - tested at Bekaert

From the prismatic beams that were saw cut from the tested slab smaller cubes were produced by further cutting in cubes to test compressive strength. The beams were taken at numbered positions in drawing TP 2:100.

Results from: SCA No. 4 beam test –fibre counting - tested at Bekaert

The fibres in the cubes surfaces were counted before compression tests.

Results from: SCA No. 4 beam test – x-ray of sliced beams - tested at Bekaert

From the prismatic beams that were saw cut from the tested slab slices were cut that were x-rayed. The fibre distribution and orientation were then made visible. The beams were taken at numbered positions in drawing TP 2:100.

Plan drawings for the material tests

Provided at the end of the Appendix A there are two drawings representing the test planes for where the material samples were taken.

TP 1:100 – Test plan for drilled-out cores.

TP 2:100 – Test plan for saw cut beams.

List of Bulletins from the Department of Structural Engineering, The Royal Institute of Technology, Stockholm

TRITA-BKN. Bulletin

Pacoste, C., On the Application of Catastrophe Theory to Stability Analyses of Elastic Structures.
Doctoral Thesis, 1993. Bulletin 1.

Stenmark, A-K., Dämpning av 13 m lång stål balk – "Ullevibalken". Utprovning av dämpmassor och fästsättning av motbalk samt experimentell bestämning av modformer och förlustfaktorer. Vibration tests of full-scale steel girders to determine optimum passive control.
Licentiatavhandling, 1993. Bulletin 2.

Silfwerbrand, J., Renovering av asfaltgolv med cementbundna plastmodifierade avjämningsmassor.
1993. Bulletin 3.

Norlin, B., Two-Layered Composite Beams with Nonlinear Connectors and Geometry – Tests and Theory.
Doctoral Thesis, 1993. Bulletin 4.

Habtezion, T., On the Behaviour of Equilibrium Near Critical States.
Licentiate Thesis, 1993. Bulletin 5.

Krus, J., Hållfasthet hos frostnedbruten betong.
Licentiatavhandling, 1993. Bulletin 6.

Wiberg, U., Material Characterization and Defect Detection by Quantitative Ultrasonics.
Doctoral Thesis, 1993. Bulletin 7.

Lidström, T., Finite Element Modelling Supported by Object Oriented Methods.
Licentiate Thesis, 1993. Bulletin 8.

Hallgren, M., Flexural and Shear Capacity of Reinforced High Strength Concrete Beams without Stirrups.
Licentiate Thesis, 1994. Bulletin 9.

Krus, J., Betongbalkars lastkapacitet efter miljöbelastning.
1994. Bulletin 10.

Sandahl, P., Analysis Sensitivity for Wind-related Fatigue in Lattice Structures.
Licentiate Thesis, 1994. Bulletin 11.

Sanne, L., Information Transfer Analysis and Modelling of the Structural Steel Construction Process.
Licentiate Thesis, 1994. Bulletin 12.

Zhitao, H., Influence of Web Buckling on Fatigue Life of Thin-Walled Columns.
Doctoral Thesis, 1994. Bulletin 13.

Kjörling, M., Dynamic response of railway track components. Measurements during train passage and dynamic laboratory loading.
Licentiate Thesis, 1995. Bulletin 14.

Yang, L., On Analysis Methods for Reinforced Concrete Structures.
Doctoral Thesis, 1995. Bulletin 15.

Petersson, Ö., Svensk metod för dimensionering av betongvägar.
Licentiatavhandling, 1996. Bulletin 16.

Lidström, T., Computational Methods for Finite Element Instability Analyses.
Doctoral Thesis, 1996. Bulletin 17.

Krus, J., Environment- and Function-induced Degradation of Concrete Structures.

Doctoral Thesis, 1996. Bulletin 18.

Editor, Silfwerbrand, J., Structural Loadings in the 21st Century.
Sven Sahlin Workshop, June 1996. Proceedings. Bulletin 19.

Ansell, A., Frequency Dependent Matrices for Dynamic Analysis of Frame Type Structures.
Licentiate Thesis, 1996. Bulletin 20.

Troive, S., Optimering av åtgärder för ökad livslängd hos infrastrukturkonstruktioner.
Licentiatavhandling, 1996. Bulletin 21.

Karoumi, R., Dynamic Response of Cable-Stayed Bridges Subjected to Moving Vehicles.
Licentiate Thesis, 1996. Bulletin 22.

Hallgren, M., Punching Shear Capacity of Reinforced High Strength Concrete Slabs.
Doctoral Thesis, 1996. Bulletin 23.

Hellgren, M., Strength of Bolt-Channel and Screw-Groove Joints in Aluminium Extrusions.
Licentiate Thesis, 1996. Bulletin 24.

Yagi, T., Wind-induced Instabilities of Structures.
Doctoral Thesis, 1997. Bulletin 25.

Eriksson, A., and Sandberg, G., (editors), Engineering Structures and Extreme Events – proceedings from a symposium, May 1997. Bulletin 26.

Paulsson, J., Effects of Repairs on the Remaining Life of Concrete Bridge Decks.
Licentiate Thesis, 1997. Bulletin 27.

Olsson, A., Object-oriented finite element algorithms.
Licentiate Thesis, 1997. Bulletin 28.

Yunhua, L., On Shear Locking in Finite Elements.
Licentiate Thesis, 1997. Bulletin 29.

Ekman, M., Sprickor i betongkonstruktioner och dess inverkan på beständigheten.
Licentiate Thesis, 1997. Bulletin 30.

Karawajczyk, E., Finite Element Approach to the Mechanics of Track-Deck Systems.
Licentiate Thesis, 1997. Bulletin 31.

Fransson, H., Rotation Capacity of Reinforced High Strength Concrete Beams.
Licentiate Thesis, 1997. Bulletin 32.

Edlund, S., Arbitrary Thin-Walled Cross Sections. Theory and Computer Implementation.
Licentiate Thesis, 1997. Bulletin 33.

Forsell, K., Dynamic analyses of static instability phenomena.
Licentiate Thesis, 1997. Bulletin 34.

Ikäheimonen, J., Construction Loads on Shores and Stability of Horizontal Formworks.
Doctoral Thesis, 1997. Bulletin 35.

Racutanu, G., Konstbyggnaders reella livslängd.
Licentiatavhandling, 1997. Bulletin 36.

Appelqvist, I., Sammanbyggnad. Datastrukturer och utveckling av ett IT-stöd för byggprocessen.
Licentiatavhandling, 1997. Bulletin 37.

Alavizadeh-Farhang, A., Plain and Steel Fibre Reinforced Concrete Beams Subjected to Combined Mechanical and Thermal Loading.
Licentiate Thesis, 1998. Bulletin 38.

Eriksson, A. and Pacoste, C., (editors), Proceedings of the NSCM-11: Nordic Seminar on Computational Mechanics, October 1998. Bulletin 39.

Luo, Y., On some Finite Element Formulations in Structural Mechanics.
Doctoral Thesis, 1998. Bulletin 40.

Troive, S., Structural LCC Design of Concrete Bridges.
Doctoral Thesis, 1998. Bulletin 41.

Tärno, I., Effects of Contour Ellipticity upon Structural Behaviour of Hyparform Suspended Roofs.
Licentiate Thesis, 1998. Bulletin 42.

Hassanzadeh, G., Betongplattor på pelare. Förstärkningsmetoder och dimensioneringsmetoder för plattor med icke vidhäftande spännarmering.
Licentiatavhandling, 1998. Bulletin 43.

Karoumi, R., Response of Cable-Stayed and Suspension Bridges to Moving Vehicles. Analysis methods and practical modeling techniques.
Doctoral Thesis, 1998. Bulletin 44.

Johnson, R., Progression of the Dynamic Properties of Large Suspension Bridges during Construction – A Case Study of the Höga Kusten Bridge.
Licentiate Thesis, 1999. Bulletin 45.

Tibert, G., Numerical Analyses of Cable Roof Structures.
Licentiate Thesis, 1999. Bulletin 46.

Ahlenius, E., Explosionslaster och infrastrukturkonstruktioner - Risker, värderingar och kostnader.
Licentiatavhandling, 1999. Bulletin 47.

Battini, J-M., Plastic instability of plane frames using a co-rotational approach.
Licentiate Thesis, 1999. Bulletin 48.

Ay, L., Using Steel Fiber Reinforced High Performance Concrete in the Industrialization of Bridge Structures.
Licentiate Thesis, 1999. Bulletin 49.

Paulsson-Tralla, J., Service Life of Repaired Concrete Bridge Decks.
Doctoral Thesis, 1999. Bulletin 50.

Billberg, P., Some rheology aspects on fine mortar part of concrete.
Licentiate Thesis, 1999. Bulletin 51.

Ansell, A., Dynamically Loaded Rock Reinforcement.
Doctoral Thesis, 1999. Bulletin 52.

Forsell, K., Instability analyses of structures under dynamic loads.
Doctoral Thesis, 2000. Bulletin 53.

Edlund, S., Buckling of T-Section Beam-Columns in Aluminium with or without Transverse Welds.
Doctoral Thesis, 2000. Bulletin 54.

Löfsjögård, M., Functional Properties of Concrete Roads – General Interrelationships and Studies on Pavement Brightness and Sawcutting Times for Joints.
Licentiate Thesis, 2000. Bulletin 55.

Nilsson, U., Load bearing capacity of steel fibre reinforced shotcrete linings.
Licentiate Thesis, 2000. Bulletin 56.

Silfwerbrand, J. and Hassanzadeh, G., (editors), International Workshop on Punching Shear Capacity of RC Slabs – Proceedings. Dedicated to Professor Sven Kinnunen. Stockholm June 7-9, 2000. Bulletin 57.

- Wiberg, A., Strengthening and repair of structural concrete with advanced, cementitious composites. Licentiate Thesis, 2000. Bulletin 58.
- Racutanu, G., The Real Service Life of Swedish Road Bridges - A case study. Doctoral Thesis, 2000. Bulletin 59.
- Alavizadeh-Farhang, A., Concrete Structures Subjected to Combined Mechanical and Thermal Loading. Doctoral Thesis, 2000. Bulletin 60.
- Wäppling, M., Behaviour of Concrete Block Pavements - Field Tests and Surveys. Licentiate Thesis, 2000. Bulletin 61.
- Getachew, A., Trafiklaster på broar. Analys av insamlade och Monte Carlo genererade fordonsdata. Licentiatavhandling, 2000. Bulletin 62.
- James, G., Raising Allowable Axle Loads on Railway Bridges using Simulation and Field Data. Licentiate Thesis, 2001. Bulletin 63.
- Karawajczyk, E., Finite Elements Simulations of Integral Bridge Behaviour. Doctoral Thesis, 2001. Bulletin 64.
- Thöyrä, T., Strength of Slotted Steel Studs. Licentiate Thesis, 2001. Bulletin 65.
- Tranvik, P., Dynamic Behaviour under Wind Loading of a 90 m Steel Chimney. Licentiate Thesis, 2001. Bulletin 66.
- Ullman, R., Buckling of Aluminium Girders with Corrugated Webs. Licentiate Thesis, 2002. Bulletin 67.
- Getachew, A., Traffic Load Effects on Bridges. Statistical Analysis of Collected and Monte Carlo Simulated Vehicle Data. Doctoral Thesis, 2003. Bulletin 68.
- Quilligan, M., Bridge Weigh-in-Motion. Development of a 2-D Multi-Vehicle Algorithm. Licentiate Thesis, 2003. Bulletin 69.
- James, G., Analysis of Traffic Load Effects on Railway Bridges. Doctoral Thesis 2003. Bulletin 70.
- Nilsson, U., Structural behaviour of fibre reinforced sprayed concrete anchored in rock. Doctoral Thesis 2003. Bulletin 71.
- Wiberg, A., Strengthening of Concrete Beams Using Cementitious Carbon Fibre Composites. Doctoral Thesis 2003. Bulletin 72.
- Löfsjögård, M., Functional Properties of Concrete Roads – Development of an Optimisation Model and Studies on Road Lighting Design and Joint Performance. Doctoral Thesis 2003. Bulletin 73.
- Bayoglu-Flener, E., Soil-Structure Interaction for Integral Bridges and Culverts. Licentiate Thesis 2004. Bulletin 74.
- Lutfi, A., Steel Fibrous Cement Based Composites. Part one: Material and mechanical properties. Part two: Behaviour in the anchorage zones of prestressed bridges. Doctoral Thesis 2004. Bulletin 75.
- Johansson, U., Fatigue Tests and Analysis of Reinforced Concrete Bridge Deck Models. Licentiate Thesis 2004. Bulletin 76.

- Roth, T., Langzeitverhalten von Spannstählen in Betonkonstruktionen.
Licentiate Thesis 2004. Bulletin 77.
- Hedebratt, J., Integrerad projektering och produktion av industrigolv – Metoder för att förbättra kvaliteten.
Licentiatavhandling, 2004. Bulletin 78.
- Österberg, E., Revealing of age-related deterioration of prestressed reinforced concrete containments in nuclear power plants – Requirements and NDT methods.
Licentiate Thesis 2004. Bulletin 79.
- Broms, C.E., Concrete flat slabs and footings New design method for punching and detailing for ductility.
Doctoral Thesis 2005. Bulletin 80.
- Wiberg, J., Bridge Monitoring to Allow for Reliable Dynamic FE Modelling - A Case Study of the New Årsta Railway Bridge.
Licentiate Thesis 2006. Bulletin 81.
- Mattsson, H-Å., Funktionsentreprenad Brounderhåll – En pilotstudie i Uppsala län.
Licentiate Thesis 2006. Bulletin 82.
- Masanja, D. P, Foam concrete as a structural material.
Doctoral Thesis 2006. Bulletin 83.
- Johansson, A., Impregnation of Concrete Structures – Transportation and Fixation of Moisture in Water Repellent Treated Concrete.
Licentiate Thesis 2006. Bulletin 84.
- Billberg, P., Form Pressure Generated by Self-Compacting Concrete – Influence of Thixotropy and Structural Behaviour at Rest.
Doctoral Thesis 2006. Bulletin 85.
- Enckell, M., Structural Health Monitoring using Modern Sensor Technology – Long-term Monitoring of the New Årsta Railway Bridge.
Licentiate Thesis 2006. Bulletin 86.
- Söderqvist, J., Design of Concrete Pavements – Design Criteria for Plain and Lean Concrete.
Licentiate Thesis 2006. Bulletin 87.
- Malm, R., Shear cracks in concrete structures subjected to in-plane stresses.
Licentiate Thesis 2006. Bulletin 88.
- Skoglund, P., Chloride Transport and Reinforcement Corrosion in the Vicinity of the Transition Zone between Substrate and Repair Concrete.
Licentiate Thesis 2006. Bulletin 89.
- Liljencrantz, A., Monitoring railway traffic loads using Bridge Weight-in-Motion.
Licentiate Thesis 2007. Bulletin 90.
- Stenbeck, T., Promoting Innovation in Transportation Infrastructure Maintenance – Incentives, Contracting and Performance-Based Specifications.
Doctoral Thesis 2007. Bulletin 91
- Magnusson, J., Structural Concrete Elements Subjected to Air Blast Loading.
Licentiate Thesis 2007. Bulletin 92.

- Pettersson, L., G., Full Scale Tests and Structural Evaluation of Soil Steel Flexible Culverts with low Height of Cover.
Doctoral Thesis 2007. Bulletin 93
- Westerberg, B., Time-dependent effects in the analysis and design of slender concrete compression members.
Doctoral Thesis 2008. Bulletin 94
- Mattsson, H-Å, Integrated Bridge Maintenance. Evaluation of a pilot project and future perspectives.
Doctoral Thesis 2008. Bulletin 95
- Andersson, A., Utmattningsanalys av järnvägsbroar. En fallstudie av stålbroarna mellan Stockholm Central och Söder Mälarstrand, baserat på teoretiska analyser och töjningsmätningar.
Licentiate Thesis 2009. Bulletin 96
- Malm, R., Predicting shear type crack initiation and growth in concrete with non-linear finite element method.
Doctoral Thesis 2009. Bulletin 97
- Bayoglu Flener, E., Static and dynamic behavior of soil-steel composite bridges obtained by field testing.
Doctoral Thesis 2009. Bulletin 98
- Gram, A., Numerical Modelling of Self-Compacting Concrete Flow
Licentiate Thesis 2009. Bulletin 99
- Wiberg, J., Railway bridge response to passing trains. Measurements and FE model updating.
Doctoral Thesis 2009. Bulletin 100
- Athuman M.K. Ngoma, Characterisation and Consolidation of Historical Lime Mortars in Cultural Heritage Buildings and Associated Structures in East Africa.
Doctoral Thesis 2009. Bulletin 101
- Ülker-Kaustell, M., Some aspects of the dynamic soil-structure interaction of a portal frame railway bridge.
Licentiate Thesis 2009. Bulletin 102
- Vogt, C., Ultrafine particles in concrete
Doctoral Thesis 2010. Bulletin 103
- Selander, A., Hydrophobic Impregnation of Concrete Structures
Doctoral Thesis 2010. Bulletin 104
- Ilina, E., Understanding the application of knowledge management to safety critical facilities
Doctoral Thesis 2010. Bulletin 105
- Leander, J., Improving a bridge fatigue life prediction by monitoring
Licentiate Thesis 2010. Bulletin 106
- Andersson, A., Capacity assessment of arch bridges with backfill – Case of the old Årsta railway bridge
Doctoral Thesis 2011. Bulletin 107
- Enckell, M., Lessons Learned in Structural Health Monitoring of Bridges Using Advanced Sensor Technology
Doctoral Thesis 2011. Bulletin 108
- Hansson, H., Warhead penetration in concrete protective structures
Licentiate Thesis 2011. Bulletin 109
- Gonzalez Silva, I., Study and Application of Modern Bridge Monitoring Techniques
Licentiate Thesis 2011. Bulletin 110

Safi, M., LCC Applications for Bridges and Integration with BMS
Licentiate Thesis 2012. Bulletin 111

Guangli, D., Towards sustainable construction, life cycle assessment of railway bridges
Licentiate Thesis 2012. Bulletin 112

Hedebratt, J., Industrial Fibre Concrete Slabs – Experiences and Tests on Pile-Supported Slab
Doctoral Thesis 2012. Bulletin 113

Ahmed, L., Models for analysis of shotcrete on rock exposed to blasting
Licentiate Thesis 2012. Bulletin 114

Le, T., N., Corotational formulation for nonlinear dynamic analysis of flexible beam structures
Licentiate Thesis 2012. Bulletin 115

The department also publishes other series. For full information see our homepage <http://www.byv.kth.se>